

Intelligent Switch Monitor Installation Guide

Part No	Product Name
SA4700-100APO	Intelligent Switch Monitor

Technical Information

All data is supplied subject to change without notice. Specifications are typical at 24V, 25°C and 50% RH unless otherwise stated.

Supply Voltage	17-35V dc
Quiescent Current	500µA
Power-up Surge Current	900µA
LED Current	1.6mA per LED
Maximum Loop Current	1A
(I_c max; L1 in/out)	
Operating Temperature	-40°C to 70°C
Humidity	0% to 95% RH (no condensation or icing)
Approvals	EN 54-17 & EN 54-18

For additional technical information please refer to the following documents which are available on request.

PP2557 - Intelligent Switch Monitor

1

i Drill holes where required.

2

! Do not over tighten screws

3

i Remove knockouts and fit glands where required.

4

5

! Do not over tighten screws

6

i See Table 1

! The 8th segment must be in set to '0' for Discovery / XP95 operation

7

! All CI tests must be carried before connecting the interface. For connectivity instruction see Figs 1, 2 & 3

8

i Note the alignment marks

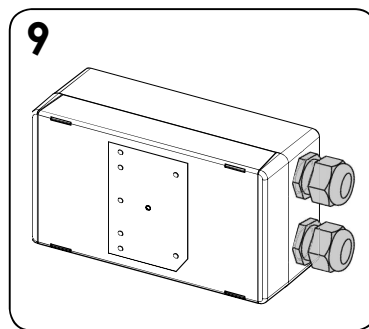

Addressing

Table 1

	XP95 / Discovery Systems	CoreProtocol Systems
Segment	1	Sets the address
	2	
	3	
	4	
	5	
	6	
	7	
8	Set to '0' (Fault value is returned if set to '1')	Sets the address
MCP	Priority interrupt - enables MCP behaviour	
DLY	Enables 30 second delay into alarm	

Note: On mixed systems addresses 127 and 128 are reserved. Refer to system's panel manufacturer for further information.

Address Setting Examples

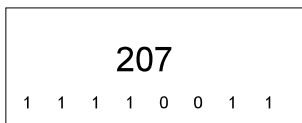
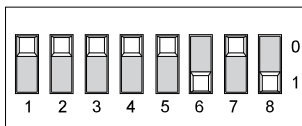
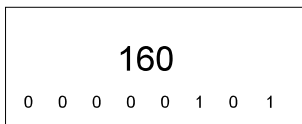
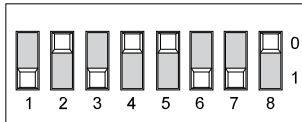
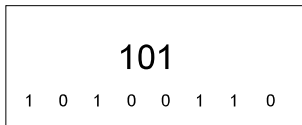
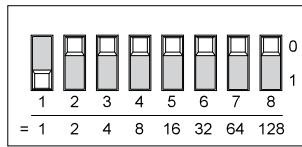

Connectivity Examples

Fig. 1 Standard resistive monitoring mode

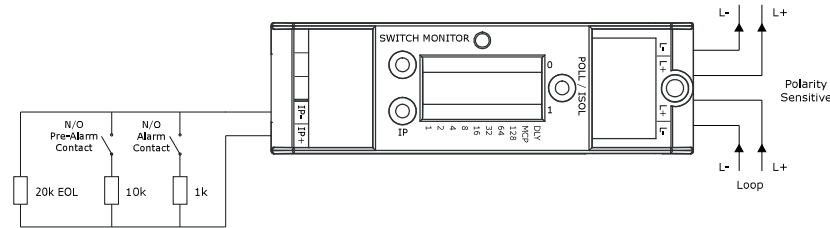

Fig. 2 Normally open monitoring mode (compatible with CoreProtocol only)

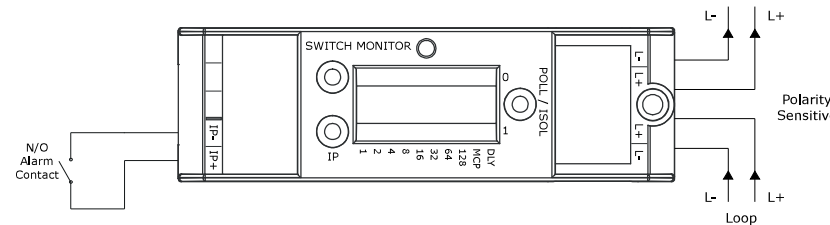
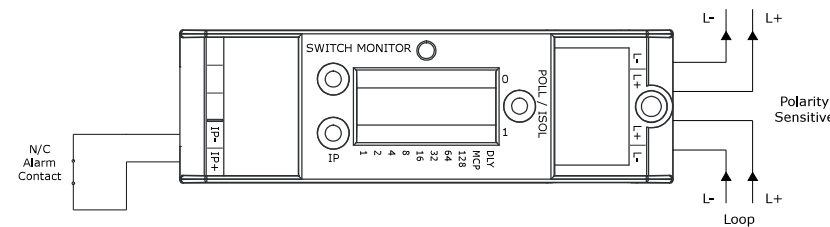

Fig. 3 Normally closed monitoring mode (Compatible with CoreProtocol only)



When operated under XP95 or Discovery Protocols, EN54-13 type 2 devices can be connected. In case EN54-13 type 1 devices need to be connected they must be installed directly next to this module, with no transmission path according to EN 54-13.

LED Status Indicator

POLL/ ISO	Flashing Green	Device Polled
	Continuous Yellow	Isolator Active
IP	Continuous Red	Input Active
	Continuous Yellow	Input Fault

Note:
Not all LEDs can be on simultaneously.

Commissioning

The installation must conform to BS5839-1 (or applicable local codes).

Maintenance

Removal of the external cover must be carried out using a flat screwdriver or similar tool.

Caution

Unit damage. No electrical supply greater than 50V ac rms or 75V dc should be connected to any terminal of this Switch Monitor.

Troubleshooting

Before investigating individual units for faults, it is important to check that the system wiring is fault free. Earth faults on data loops or interface zone wiring may cause communication errors. Many fault conditions are the result of simple wiring errors. Check all connections to the unit.

Problem	Possible Cause
No response or missing	Incorrect address setting Incorrect loop wiring
Fault condition reported	Incorrect input wiring Incorrect end-of-line resistor fitted
Analogue value unstable	Dual address Loop data fault, data corruption
Constant alarm or pre-alarm	Incorrect wiring Incorrect end-of-line resistor fitted
Isolator LED on	Short-circuit on loop wiring Wiring reverse polarity Too many devices between isolators

Mode Table*

Mode	Description
1	DIL Switch XP Mode
2	Switch monitor - normal resistance bands with alarm delays
3	Priority switch monitor - normal resistance bands
4	Switch monitor - N/C input with alarm delays
5	Priority switch monitor - N/C input

*CoreProtocol enabled systems only