

# B2N45H-Q20L60-2LU3-H1151 Inclinometer

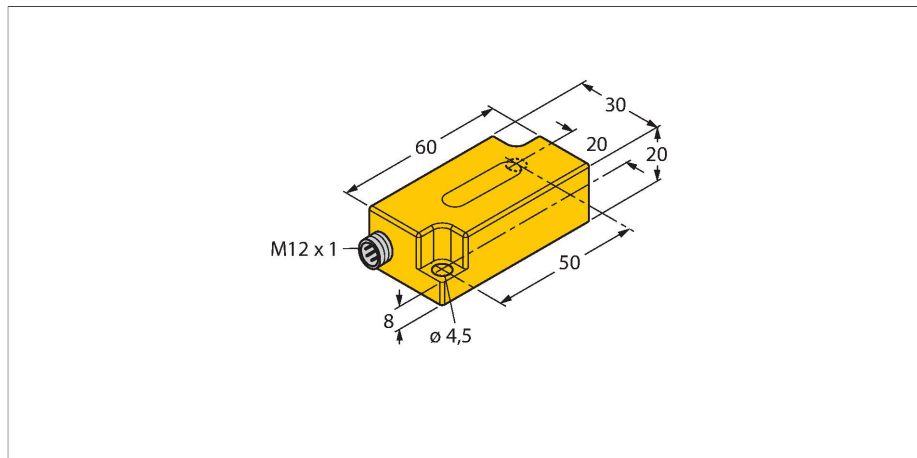

## Features

- Plastic, PC
- Zero point calibration  $\pm 15^\circ$
- Two analog outputs
- M12 x 1 male connector

## Wiring diagram

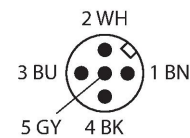
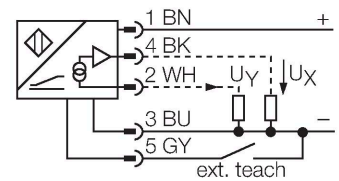

## Technical data

Type	B2N45H-Q20L60-2LU3-H1151
ID	1534007
Measuring principle	Acceleration
<b>General data</b>	
Measuring range	$-45 \dots 45^\circ$
Measuring range x-axis	$-45 \dots 45^\circ$
Measuring range y-axis	$-45 \dots 45^\circ$
Number of measuring axes	2
Repeatability	$\leq 0.2\%$ of measuring range $ A - B $
Linearity deviation	$\leq 0.5\%$
Temperature drift	$\leq \pm 0.04\%$ / K
Resolution	$\leq 0.1^\circ$
<b>Electrical data</b>	
Operating voltage	10...30 VDC
Isolation test voltage	$\leq 0.5$ kV
Short-circuit protection	yes
Wire breakage/Reverse polarity protection	no / yes
Surge protection	$-48 \dots 48$ VDC $[U_{b,max}]$
Output function	5-pin, Analog output
Voltage output	0.1...4.9 V
Load resistance voltage output	$\geq 40$ k $\Omega$
Response time	0.1 s
	time for the output signal to achieve 90% full scale if the angle changes from $-45^\circ$ to $+45^\circ$
Current consumption	50 mA

## Functional principle

Inclination is determined by a wear-free semiconducting sensor element.

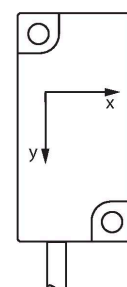
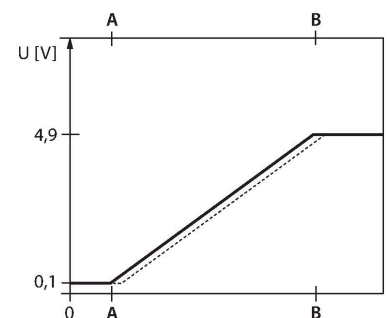
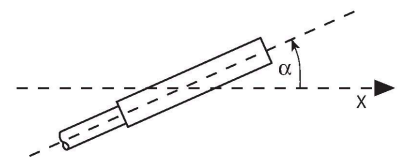

## Technical data

Mechanical data	
Design	Rectangular, Q20L60
Dimensions	60 x 30 x 20 mm
Housing material	Plastic, PC
Electrical connection	Connector, M12 × 1
Environmental conditions	
Ambient temperature	-30...+70 °C
Vibration resistance	55 Hz (1 mm)
Shock resistance	30 g (11 ms)
Protection class	IP68 IP69K
MTTF	203 years acc. to SN 29500 (Ed. 99) 40 °C

## Mounting instructions

### Mounting instructions/Description

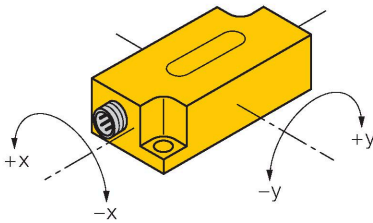

#### Teaching

The zero point can be adjusted with teach adapter TX1-Q20L60.

Teach-GND is pressed for approx. 1 s to do this. The outputs are switched to 5 V as confirmation.

Teach-GND is pressed for 6 s to reset the axis zero points. The outputs are switched to 0 V as confirmation.

Once the teach button is released, the sensor returns to normal operation.

## Accessories

### GUARD-Q20L60

### A9684

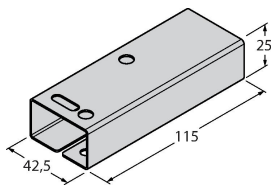

Protective housing for Q20L60 inclinometers for protecting against mechanical impact; material: Stainless steel

Accessories

Dimension drawing	Type	ID	
	TX1-Q20L60	6967114	Teach adapter for inductive encoders, linear position, angle, ultrasonic and capacitive sensors