



HMT330 Series Humidity and Temperature Transmitters

For Demanding Humidity Measurement



Features

- Full 0 ... 100 %RH measurement, temperature range up to +180 °C (+356 °F) depending on model
- Pressure tolerance up to 100 bar depending on model
- 4th generation Vaisala HUMICAP® sensor for superior accuracy and stability
- Corrosion-resistant IP65/IP66 housing
- Excellent performance in harsh conditions; good chemical tolerance
- Traceable calibration for measurement and analog outputs (certificates included)
- 10-year warranty when annually calibrated at the Vaisala Service Center

Vaisala HMT330 Series HUMICAP® Humidity and Temperature Transmitters are designed for demanding industrial applications where stable measurements and extensive customization are essential. With multiple options to choose from, the instrument can be tailored to meet the specific needs of each individual application and is pre-configured for each delivery.

Proven Vaisala HUMICAP Performance

The HMT330 series incorporates Vaisala's 40 years of experience in industrial humidity measurement. The updated fourth-generation HUMICAP® sensor provides accurate and stable measurement even in environments with high humidity or chemical contaminants.

Wide Range of Installation Options

The wide variety of measurement probes, several installation accessories, and universal mains and DC power options make the instruments easy to install in various locations and kinds of environment; walls, poles, pipelines, and

ducts, for example. The input/output cable can be fed through the back of the transmitter, which is a useful feature, especially for cleanroom installations.

The HMT330 series includes six models:

- HMT331 for wall-mounted applications
- HMT333 for ducts and tight spaces
- HMT334 for high-pressure and vacuum applications
- HMT335 for high-temperature applications
- HMT337 for high-humidity applications
- HMT338 for pressurized pipelines

With multiple options to choose from, including local display, the HMT330 series can be tailored to meet the specific needs of each individual

application and is preconfigured for each delivery. Also the HUMICAP® sensor itself can be selected according to specific measurement application needs.

Connectivity

- RS-232/485/422 LAN
- Modbus protocol support (RTU/TCP)
- Optional graphical display and keypad for convenient operation
- Multilingual user interface
- Compatible with Vaisala viewLinc software

HMT330 Series Humidity and Temperature Transmitters

Graphical Display of Measurement Data and Trends for Convenient Operation

The HMT330 series features an optional numerical and graphical display with a multilingual menu and keypad. It allows users to easily monitor operational data, measurement trends, and access measurement history of up to 4 years.

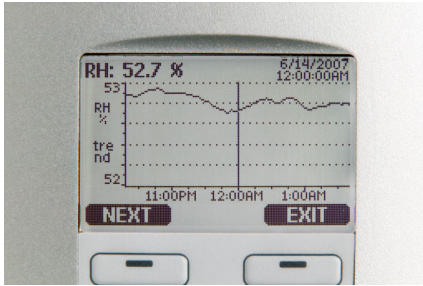

The display shows measurement trends and over four years of real-time measurement history.

The display alarm allows any measured parameter to be tracked, with freely configurable low and high limits.

Versatile Outputs and Data Collection

The HMT330 can support up to three analog outputs; an isolated galvanic power supply and up to four relay outputs are also available.

For serial interface the USB service cable, RS-232, and RS-485/422 can be used.

HMT330 is also capable of applying the Modbus communication protocol and, together with an appropriate connection option, provides either Modbus RTU (RS-485) or Modbus TCP/IP (Ethernet) communication.

The data logger, with real-time clock and battery backup, guarantees reliable logging of measurement data for over four years. The recorded data can be viewed on the local display or transferred to a PC with Microsoft Windows® software. The transmitter can also be connected to a network with an optional LAN interface, which enables an Ethernet connection. A USB service cable makes it easy to connect the HMT330 to a PC via the service port.

Flexible Calibration

The HMT330 instruments are calibrated at five humidity points at the factory and come with a calibration certificate that meets all the relevant traceability and compliance requirements.

A quick, one-point field calibration can be performed with the handheld HM70 meter. A two-point field calibration can be performed, for example, with the

HMK15 salt bath calibrator in a controlled environment. The transmitter can also be sent to Vaisala for recalibration, and accredited ISO/IEC17025 calibrations and special calibrations are available.



Handheld Humidity and Temperature Meter HM70 is ideal for field checking HMT330 transmitters.

Chemical Purge Minimizes Effects of Contaminant

In environments with high concentrations of chemicals and cleaning agents, the chemical purge option helps to maintain measurement accuracy between calibration intervals.

The chemical purge involves heating the sensor to remove harmful chemicals. The function can be initiated manually or programmed to occur at set intervals.

	HMT331	HMT333	HMT334	HMT335	HMT337	HMT338
For	Measurement within rooms	General purposes	High pressure and vacuum applications	High temperatures	High humidity applications	Pressurized pipelines
Temperature Measurement Range	-40 ... +60 °C (-40 ... +140 °F)	-40 ... +80 °C (-40 ... +176 °F) or -40 ... +120 °C (-40 ... +248 °F)	-70 ... +180 °C (-94 ... +356 °F)	-70 ... +180 °C (-94 ... +356 °F)	-70 ... +180 °C (-94 ... +356 °F)	-70 ... +180 °C (-94 ... +356 °F)
Operating Pressure			0 ... 10 MPa (0 ... 100 bar)		0 ... 1 MPa (0 ... 10 bar)	0 ... 4 MPa (0 ... 40 bar)

HMT330 Series Technical Data

Measurement Performance

Relative Humidity

Measurement range	0 ... 100 %RH
Accuracy (including non-linearity, hysteresis, and repeatability)	
at +15 ... +25 °C (59 ... +77 °F)	±1 %RH (0 ... 90 %) ±1.7 %RH (90 ... 100 %RH)
at -20 ... +40 °C (-4 ... +104 °F)	±(1.0 + 0.008 x reading) %RH
at -40 ... +180 °C (-40 ... +356 °F)	±(1.5 + 0.015 x reading) %RH
Factory calibration uncertainty ¹⁾ (+20 °C)	±0.6 %RH (0 ... 40 %RH) ±1.0 %RH (40 ... 97 %RH)
Response time (90%) with HUMICAP® 180 or 180C sensor at +20 °C (+68 °F) in still air	
with grid filter	8 s
with grid + steel netting filter	20 s
with sintered filter	40 s
Response time (90%) with HUMICAP® 180R, 180RC, or 180VC sensor at +20 °C (+68 °F) in 0.1 m/s air flow	
with grid filter	17 s
with grid + steel netting filter	50 s
with sintered filter	60 s

Temperature

Accuracy at +20 °C (+68 °F)	± 0.2 °C (± 0.36 °F)
Accuracy over temperature range (measurement range depends on model)	

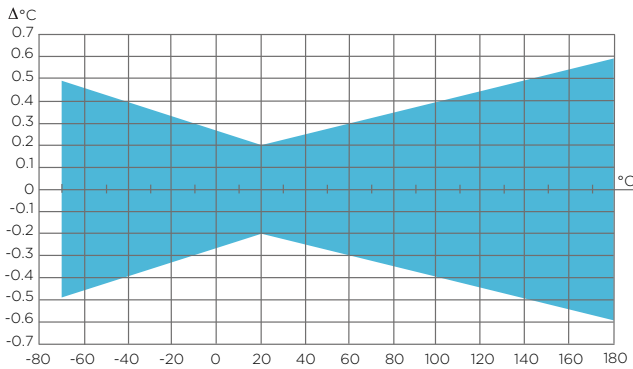

Temperature sensor Pt100 RTD Class F0.1 IEC 60751

Other Available Variables (Model-Dependent)

dew point temperature, mixing ratio, absolute humidity, wet bulb temperature, enthalpy, water vapor pressure

¹⁾ Defined as ±2 standard deviation limits. Small variations possible; see also calibration certificate.

Operating Environment

Operating Temperature

for probe	same as measurement range
for transmitter body	-40 ... +60 °C (-40 ... 140 °F)
with display	0 ... +60 °C (32 ... 140 °F)
Storage temperature	-55 ... +80 °C (-67 ... 176 °F)
EMC compliance	EN61326-1, Industrial Environment Note: Transmitter with display test impedance of 40 Ω is used in IEC61000-4-5 (Surge immunity)

Mechanical Specifications

Cable bushing	M20 x 1.5 for cable diameter 8 ... 11 mm / 0.31 ... 0.43"
Conduit fitting	1/2" NPT
User cable connector (optional)	M12 series 8-pin (male)
option 1	female plug with 5 m (16.4 ft.) black cable
option 2	female plug with screw terminals
Probe Cable Diameter	
HMT333 (+80 °C)	6.0 mm
other probes	5.5 mm
Standard probe cable lengths	2 m, 5 m or 10 m (Additional lengths available, see order forms for details)
Housing material	G-AISI 10 Mg (DIN1725)
IP rating	IP66 IP65 (NEMA4X) with local display
Weight	1.0 ... 3.0 kg depending on selected model and options

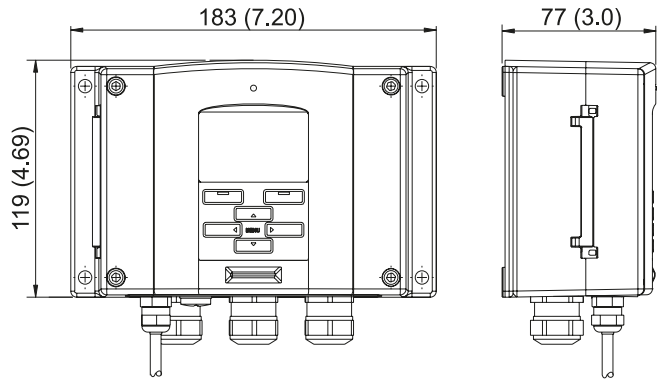

Dimensions in mm (inches)

Inputs and Outputs

Operating Voltage	10 ... 35 VDC, 24 VAC ±20%
with optional power supply module	100 ... 240 VAC, 50/60 HZ

Power Consumption at +20 °C (U_{in} 24 VDC)

RS-232	max. 25 mA
U _{out} 2 x 0 ... 1 V/0 ... 5 V/0 ... 10 V	max. 25 mA
I _{out} 2 x 0 ... 20 mA	max. 60 mA
display and backlight	+ 20 mA
during chemical purge	max. 110 mA
during probe heating (HMT337)	+ 120 mA

Analog Outputs (2 standard, 3rd optional)

current output	0 ... 20 mA, 4 ... 20 mA
voltage output	0... 1 V, 0... 5 V, 0... 10 V
Accuracy of analog outputs at +20 °C	±0.05% full scale
Temperature dependence of the analog outputs	±0.005%/°C full scale

External loads:

current outputs	R _L < 500 Ω
0 ... 1 V output	R _L > 2 kΩ
0 ... 5 V and 0 ... 10 V outputs	R _L > 10 kΩ

Max. Wire Size

0.5 mm² (AWG 20)

stranded wires recommended

Digital outputs

RS-232, RS-485 (optional)

Protocols

ASCII commands, Modbus RTU

Service Connection

RS-232, USB

Relay Outputs (Optional)

0.5 A, 250 VAC

Ethernet Interface (Optional)

Supported standards	10BASE-T, 100BASE-TX
Connector	8P8C (RJ45)
IPv4 address assignment	DHCP (automatic), static
Protocols	Telnet, Modbus TCP/IP

Optional Data Logger with Real-Time Clock

Logged parameters	max. four with trend/min/max values
Logging interval	10 sec. (fixed)
Max. logging period with max. temporal resolution	4 years, 5 months
Logged points	13.7 million points per parameter
Battery lifetime	min. 5 years

Display

LCD with backlight, graphical trend display of any parameter

Menu languages

English, Chinese, Finnish, French, German, Japanese, Russian, Spanish, Swedish

Mounting Options

Mounting with Wall Mounting Kit (not mandatory for wall installations)

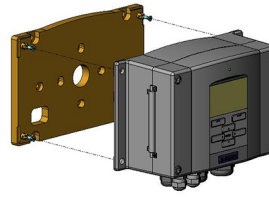

Mounting with DIN Rail Installation Kit

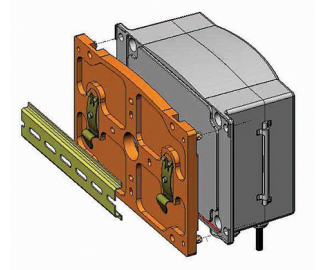

Pole Installation with Installation Kit for Pole or Pipeline

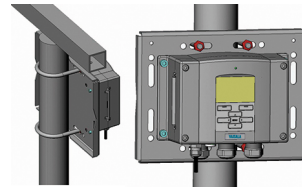

Mounting Rain Shield with Installation Kit

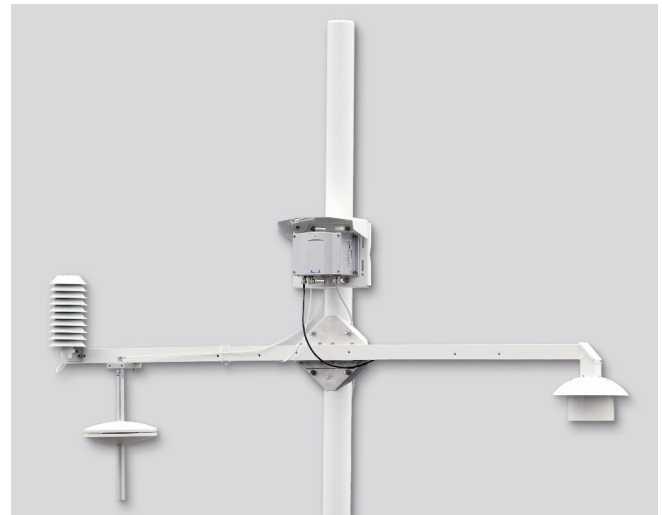
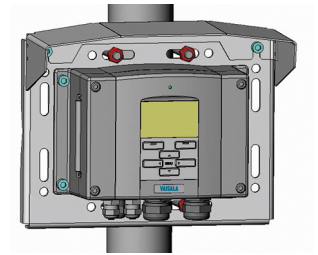

Vaisala Meteorological Installation Kit HMT330MIK enables HMT337 to be installed outdoors to obtain reliable measurements for meteorological purposes

HMT331 for Wall Mounting

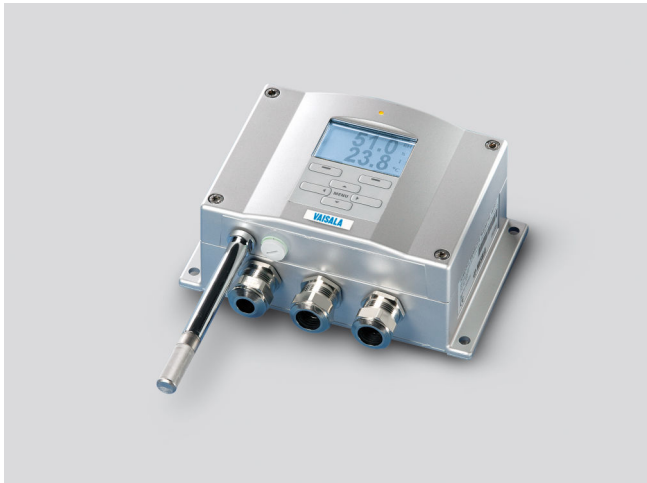

Typical Applications

- Cleanrooms
- Pharmaceutical processes
- Indoor swimming pools
- Data centers
- Archives

Vaisala HUMICAP® Humidity and Temperature Transmitter HMT331 is a high-quality wall-mounted transmitter for demanding HVAC and condition-monitoring applications.

Technical Data

Temperature measurement range -40 ... +60 °C (-40 ... +140 °F)

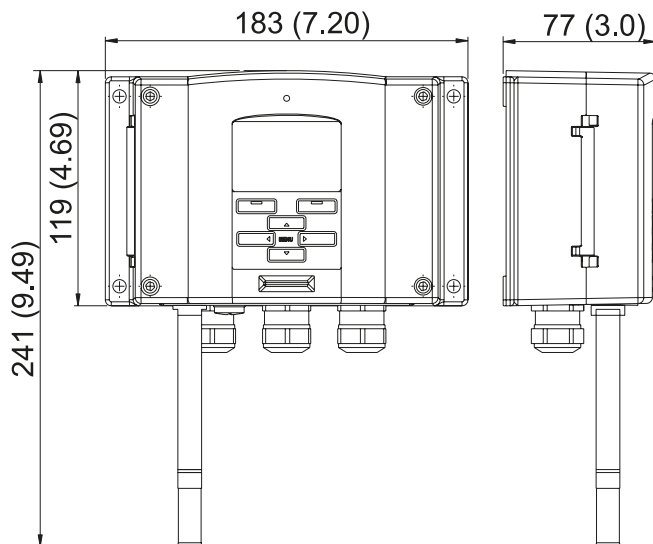

Dimensions in mm (inches)

Accessories

USB service port cable with PC software	219916
Connection cable for HM70	211339
Wall-mounting plate (plastic)	214829
Pole installation kit with rain shield	215109
DIN rail installation set	215094
PPS plastic grid filter with stainless steel net	DRW010281SP
Stainless steel sintered filter	HM47280SP



HMT331 with short cable probe

HMT333 with Short Probe for Confined Spaces and Ducts



Typical Applications

- Cleanrooms
- Industrial HVAC systems
- Environmental chambers
- Processes with moderate temperature and humidity

Technical Data

Temperature measurement range -40 ... +80 °C (-40 ... +176 °F) or
 -40 ... +120 °C (-40 ... +248 °F)

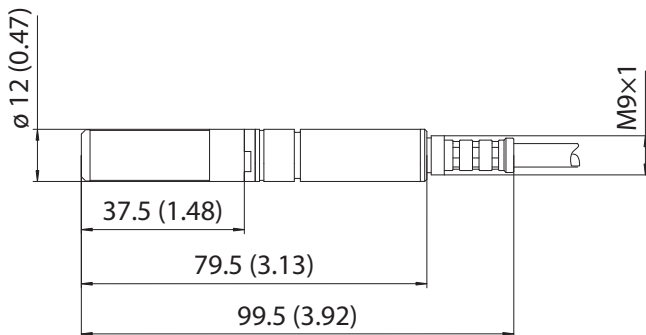

Dimensions in mm (inches)

Accessories

Duct installation kit	210697
Cable gland with split seal	HMP247CG
USB service port cable with PC software	219916
Connection cable for HM70	211339
Wall-mounting plate (plastic)	214829
Pole installation kit with rain shield	215109
Solar radiation shield	DTR502B
DIN rail installation set	215094
PPS plastic grid filter with stainless steel net	DRW010281SP
PPS plastic grid filter	DRW010276SP
Stainless steel sintered filter	HM47280SP

Vaisala HUMICAP® Humidity and Temperature Transmitter HMT333 is a versatile instrument for applications where a small remote probe is needed, for example in demanding HVAC applications. Its small thermal mass enables rapid response to temperature changes.

Flexible Installation

To install the probe in ducts, channels, and through walls, an installation kit is available with a stainless steel flange, lead-through piece, and steel support bar.

HMT333 has two probe cable options – a flexible rubber cable that withstands temperatures of up to +80 °C, and a durable FEP cable that withstands temperatures of up to +120 °C. Both cable options are available in lengths of 2, 5, and 10 meters. Additionally, flexible rubber cable (+80 °C) is available in 20-meter lengths.

For outdoor environments, the DTR502B solar radiation shield provides protection for the probe. The shield can be installed on a pole, beam, or flat surface.

Duct installation kit for HMT333. The flange allows easy adjustment of probe installation depth.

Installation flange dimensions in mm (inches)

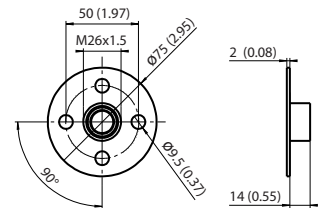

HMT334 with Threaded Connection for High Pressure, Vacuum, and/or High Temperatures



Typical Applications

- Test chambers
- High-pressure and vacuum processes

Vaisala HUMICAP® Humidity and Temperature Transmitter HMT334 is designed for humidity measurement in pressurized spaces or vacuum chambers.

Every probe is tested for gas and vacuum-tight installation.

Technical Data

Temperature measurement range	-70 ... +180 °C (-94 ... +356 °F)
Operating pressure	0 ... 10 MPa (0 ... 100 bar)

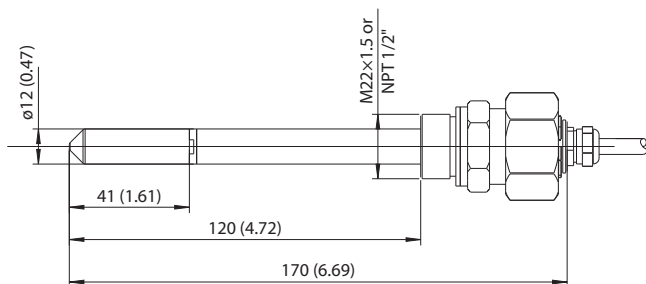

Dimensions in mm (inches)

Accessories

Fitting body NPT 1/2"	17225SP
USB service port cable with PC software	219916
Connection cable for HM70	211339
Wall-mounting plate (plastic)	214829
Pole installation kit with rain shield	215109
DIN rail installation set	215094
PPS plastic grid filter with stainless steel net	DRW010281SP
PPS plastic grid filter	DRW010276SP
Stainless steel sintered filter	HM47280SP
Stainless steel grid filter	HM47453SP
Fitting body ISO M22 x 1.5	17223SP

HMT335 with Long Probe for High Temperatures



Typical Applications

- Hot drying processes
- Food processes, e.g. baking ovens

Robust Probe Ideal for High Flow Rates

The Vaisala HUMICAP® Humidity and Temperature Transmitter HMT335 has a long stainless steel probe designed for high temperatures.

With high tolerance for mechanical stress and high flow rates, HMT335 is ideal for duct measurements. The stainless steel installation flange allows easy adjustment of the probe's installation depth. Long, robust probe allows easy installation through insulation in ovens and similar applications.

Technical Data

Temperature measurement range -70 ... +180 °C (-94 ... +356 °F)

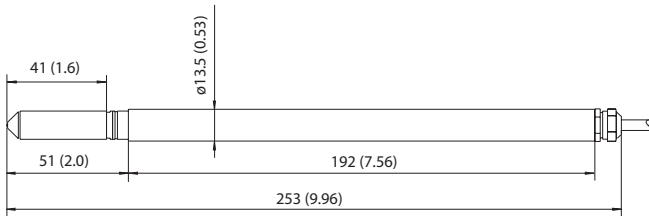

Dimensions in mm (inches)

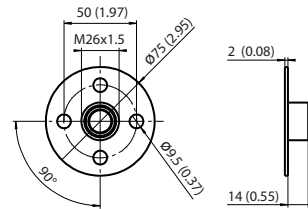

Installation flange dimensions in mm (inches)

Accessories

Mounting flange	210696
USB service port cable with PC software	219916
Connection cable for HM70	211339
Wall-mounting plate (plastic)	214829
Pole installation kit with rain shield	215109
DIN rail installation set	215094
PPS plastic grid filter with stainless steel net	DRW010281SP
PPS plastic grid filter	DRW010276SP
Stainless steel sintered filter	HM47280SP
Stainless steel grid filter	HM47453SP

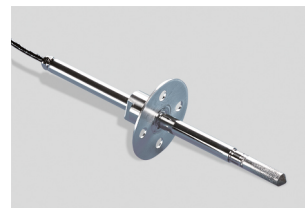

Flange installation kit for HMT335

HMT337 with Short Probe for High Humidity and/or Temperature



Typical Applications

- Professional meteorology
- Intake air monitoring of engines and gas turbines
- Timber drying kilns

HMT337 Configurations

Vaisala HUMICAP® Humidity and Temperature Transmitter HMT337 is ideal for the most demanding process and meteorological measurements in high-humidity condensing environments.

HMT337 is delivered in one of three configurations:

1. Basic HMT337, with a non-warmed probe for applications where humidity levels are not constantly near condensation

Technical Data

Temperature measurement range -70 ... +180 °C (-94 ... +356 °F)

Accessories

Cable gland for probe cable	HMP247CG
Duct installation kit (RH probe) ¹⁾	210697
Duct installation kit (T probe) ¹⁾	215003
Swagelok fittings (NPT and ISO) for both RH and T probes (up to 10 bar)	
Solar radiation shield	DTR502B
Meteorological installation kit	HMT330MIK
USB service port cable with PC software	219916
Connection cable for HM70	211339
Wall-mounting plate (plastic)	214829
Pole installation kit with rain shield	215109
DIN rail installation set	215094
Warmed probe accessory	HMT330WPA
PPS plastic grid filter with stainless steel net	DRW010281SP
PPS plastic grid filter	DRW010276SP
Stainless steel sintered filter	HM47280SP
Stainless steel grid filter	HM47453SP

For more installation accessories, check the order form.

¹⁾ For an image of the duct installation kit, see HMT333 page.

2. HMT337 with a warmed probe, for dew point temperature measurement under constant near-condensing conditions
3. HMT337 with a warmed probe and an additional temperature sensor, for relative humidity measurement under constant near-condensing conditions

True Humidity Readings in Condensation Conditions

Vaisala's unique warmed probe provides fast and reliable measurement in environments where humidity is near saturation. The heating prevents condensation from forming on the sensor.

As the probe is heated, the relative humidity level inside it stays below the ambient level. With accurate temperature measurement, the ambient dew point temperature can be calculated precisely.

If the relative humidity value is needed, an optional temperature sensor is used (configuration option 3). The measured ambient temperature provides the compensation for calculating relative humidity and other temperature-dependent humidity parameters.

Installation Options

A pressure and vapor tight installation up to 10 bars through a process wall can be achieved by sealing with Swagelok® fittings from the probe, or sealing from the cable with a gland. The optional HMT330MIK Installation Kit is available for outdoor installations; duct installation kits are also available.

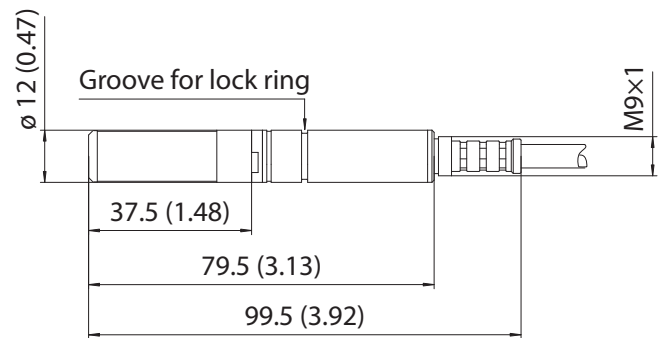

HMT337 RH Dimensions in mm (inches)

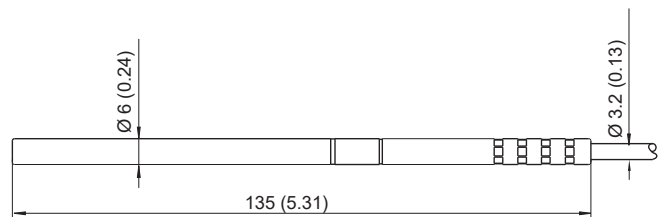

HMT337 T Dimensions in mm (inches)

HMT338 with Adjustable Insertion Depth for High Pressure, Vacuum, and/or High Temperatures



Typical Applications

- Process lines
- Environmental chambers
- Vacuum-drying processes
- Compressed air lines with refrigerant dryers

Vaisala HUMICAP® Humidity and Temperature Transmitter HMT338 is ideal for installations in pressurized processes where the probe needs to be removed while the process is running.

Insert or Remove the Probe while the Process is Running

With “hot tapping”, the probe is inserted directly into the process while it is running, without the need for venting or lowering the process pressure. The probe is tightened to a ball-valve assembly fixed to the process pipe or wall. The adjustable hex nut is hand-tightened to hold the probe in place temporarily.

The probe is then pushed down to the appropriate depth. The hex nut is then tightened with a wrench to lock the probe in place. Hot tapping is possible in pressures up to 10 bar.

Technical Data

Temperature measurement range	-70 ... +180 °C (-94 ... +356 °F)
Operating pressure	0 ... 4MPa (0 ... 40 bar)

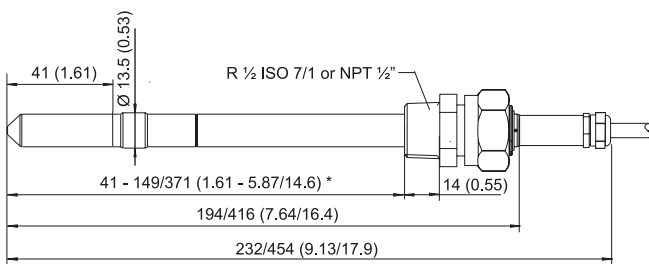

Lengths for standard / optional probes
* freely user-adjustable length

Dimensions in mm (inches)

Accessories

Ball-valve set	BALLVALVE-1
Pressure fitting ISO 1/2 to NPT 1/2	210662
USB service port cable with PC software	219916
Connection cable for HM70	211339
Wall-mounting plate (plastic)	214829
Pole installation kit with rain shield	215109
DIN rail installation set	215094
PPS plastic grid filter with stainless steel net	DRW010281SP
PPS plastic grid filter	DRW010276SP
Stainless steel sintered filter	HM47280SP
Stainless steel grid filter	HM47453SP



VAISALA

www.vaisala.com

Published by Vaisala | B210951EN-P © Vaisala 2019

All rights reserved. Any logos and/or product names are trademarks of Vaisala or its individual partners. Any reproduction, transfer, distribution or storage of information contained in this document is strictly prohibited. All specifications – technical included – are subject to change without notice.