



I N N O V A T I N G F O R E F F I C I E N C Y











MDT Series 4-20mA with Auto Zero

Pressure transmitters with integrated amplifier
for high temperatures and high pressures

Operating manual



Table of Contents

Content	Chapter	Page	Icon
General	1	3	
Notes on safety	2	5	
Technical data	3	7	
Function	4	14	
Transport/ delivery	5	16	
Installation	6	17	
Commissioning	7	25	
Maintenance	8	27	
Accessories	9	30	
Troubleshooting	10	31	
CE - Declaration of conformity	11	32	



1. General

1.1	Important information	3
1.2	Copyright	3
1.3	Explanation of icons	4
1.4	Abbreviations	4
1.5	Correct use	4
1.6	User's obligations	4

1.1 Important information

This manual applies to the MDT 420x/460x and PT 420x/460x series, 2-wire with Auto Zero, only. It must be kept near the equipment in a readily and immediately accessible location at all times.

The content of this manual must be read, understood and followed in all points by all relevant people. This applies in particular to the notes on safety. Following the safety instructions will help to prevent accidents, defects and malfunctions.

DYNISCO will not be held liable for any injury, loss or damage resulting from failure to follow the instructions in this manual.

If malfunctions occur in spite of having followed the operating instructions, please contact the **DYNISCO** customer service department (see chapter 8, Maintenance).

This applies in particular during the warranty period.

1.2 Copyright

Copyright law requires that this manual be used for in-house purposes only.

All reproduction, even partially and for in-house purposes, requires the approval of **DYNISCO**. This manual may not be forwarded to third parties.



1.3 Explanation of icons

The manual uses icons to indicate information pertaining to safety:

ATTENTION Risk of destruction or damage to equipment, machines or installations



General danger to life or limb



Specific danger to life or limb



You **MUST** do this

The safety instructions are provided again in the individual chapters of the manual.

1.4 Abbreviations

The following abbreviations are used:

OM	Operating manual
PT	pressure transmitter
f.s.	of full scale

1.5 Correct use

The purpose of the MDT or PT 420x/460x pressure transmitter is to measure pressure in plastic melt as part of a larger overall system. It contains an integrated signal amplifier. The MDT or PT 420x/460x can be used in media temperatures up to 400°C.

If the PT is used in other applications, the safety and accident prevention regulations specific to that application must be followed.

When using the PT as a safety component in accordance with the EC Machine Directive, Annex IIc, the equipment manufacturer must take any necessary precautions to ensure that malfunctions of the PT cannot cause damage or injury.

1.6 User's obligations

The operator or owner of the larger overall system, e.g. a machine, is responsible for following the safety and accident prevention regulations that apply to the specific application.



2. Notes on safety



The operator or owner of the larger overall system is responsible for following the safety and accident prevention regulations that apply to the specific application.



Toxic hazard!

The PT contains a small amount (7 mm³) of mercury (Hg) as its transmission medium. If the diaphragm is damaged, mercury may escape.

Never transport or store the PT without the protective shell bolted in place. Remove the shell shortly before installation.

If mercury is inhaled or swallowed, seek medical attention immediately!

Mercury is hazardous waste and must be disposed of in accordance with applicable laws. **DYNISCO** will accept defective PTs.

If mercury escapes, use airtight packaging!



When planning machinery and using the PT, follow the safety and accident prevention regulations that apply to your application, e.g.:

- EN 60204, Electrical equipment in machines.
- EN 292, Machine safety, general design guidelines.
- DIN 57 100 Part 410, Protection against electric shock.



Mounting and electrical connection of the PT must be done by specialists with EMC training, following all applicable regulations, and in **pressureless, voltage-free** condition with the **machine switched off**.

The machine must be secured against being switched back on!



Burn hazard!

The PT must be removed with the melt in molten condition. The PT can be very hot when removed.



Wear protective gloves!



3. Technical Data

3.1	Ordering guide	6
3.2	Ordering example	6
3.3	Performance characteristics	7
3.3.1	Accuracy	7
3.3.2	Repeatability	7
3.3.3	Resolution	7
3.4	Mechanical configurations	7
3.5	Pressure side connection	7
3.6	Pressure ranges	7
3.6.1	Pressure ranges in bar	7
3.6.2	Max. Overload	8
3.6.3	Burst pressure	8
3.6.4	Limit frequency	8
3.7	Rigid stem/flexible stem	8
3.8	Electrical Data	8
3.9	Temperature influence	9
3.10	EMC requirements	9
3.11	Materials	9
3.12	Mounting torque	9
3.13	Environmental Protection	9
3.14	Weight	9
3.15	Dimensions	10

3.1 Ordering guide

xDT4xx x- xx - xxx - x - Option

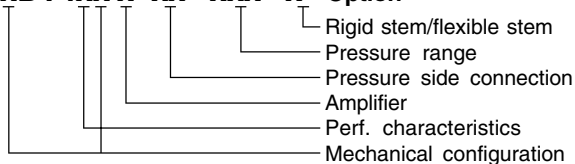

The exact meanings of the letter/digit combinations are given in the corresponding sections of chapter 3.

3.2 Ordering example

MDT462 F - ½ - 5C - 15/46

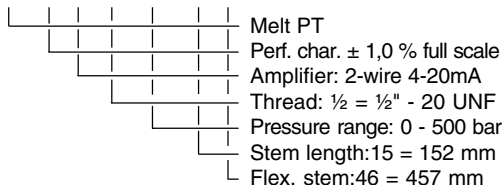



3.3 Performance characteristics (xDT4Xx x-xx-xxx-xx)

3.3.1 Accuracy

(Linearity and hysteresis at T = constant)

xDT42x x	± 0,5 % of full scale
(35 bar and 50 bar	± 1 % of full scale)
xDT46x x	± 1 % of full scale

3.3.2 Repeatability

xDT42x x	± 0,1 % of full scale
(35 bar and 50 bar	± 0,2 % of full scale)
xDT46x x	± 0,2 % of full scale

3.3.3 Resolution

infinite

3.4 Mechanical configurations (XDT4xX x-xx-xxx-xx)

MDT4x0	stem version
MDT4x2	rigid stem and flexible stem
TDT432/463	combined pressure and temperature measurement transducer for limited installation space
MDT435/467	

3.5 Pressure side connection (xDT4xx x-XX-xxx-xx)

½ = ½" 20 UNF 2A
M18 = M18 x 1,5

3.6 Pressure ranges (xDT4xx x-xx-XXX-xx)

3.6.1 Pressure ranges in bar

Model number	Permitted pressure range in bar
xDT4xx x-xx-17-xx	0 - 17 series 42x x/43x x only
xDT4xx x-xx-35-xx	0 - 35 series 42x x/43x x only
xDT4xx x-xx-50-xx	0 - 50 series 42x x/43x x only
xDT4xx x-xx-1C-xx	0 - 100
xDT4xx x-xx-2C-xx	0 - 200
xDT4xx x-xx-3,5C-xx	0 - 350
xDT4xx x-xx-5C-xx	0 - 500
xDT4xx x-xx-7C-xx	0 - 700
xDT4xx x-xx-1M-xx	0 - 1000
xDT4xx x-xx-1,4M-xx	0 - 1400
xDT4xx x-xx-2M-xx	0 - 2000
Other pressure ranges on request	



3.6.2 Max. Overload (without influencing operating data)

2 x full scale pressure up to 700 bar
 (for 1000 bar and 1400 bar range: max. 1750 bar,
 and 2450 bar for the 2000 bar range)

3.6.3 Burst pressure 6 x nominal value,
 max. 3000 bar

3.6.4 Limit frequency 50 Hz [-3db]

3.7 Rigid stem/flexible stem (xDT4xx x-xx-xxx-XX)

15 = 152 mm standard length for rigid version
 15/46 = 152 mm stem length / 457 mm flexible stem

Other lengths on request

3.8 Electrical data (xDT4xx X-xx-xxx-xx)

Configuration 4-arm Wheatstone bridge
 strain gauge with int. amplifier

Output signal
 xDT4xx F-xx-xxx-xx 2-wire 4 - 20 mA

Strain resistance
 2 - wire mA $R_L < 1200 \Omega$ at $U_s = 36 V$
 $R_L < 50 \Omega$ at $U_s = 14 V$

Supply voltage / power consumption
 2 - wire mA 14 - 36 VDC

Calibration function 80 % \pm 0,5 % of full scale
 (room temperature) output by externally connecting contacts E and F

Zero balance Use button or externally connected contacts D + F to zero-balance the unit

Leakage resistance $> 1000 M\Omega$ at 50 V

3.9 Temperature influence

Electronics housing

Max. housing temperature -25 °C - +85 °C

Compensated temp. range 0 °C - +70 °C



Zero shift due to temperature change on electronics housing

xDT 420 x series $\pm 0,2\%$ full scale / 10 °C typ.
 xDT 460 x series $\pm 0,2\%$ full scale / 10 °C typ.

Sensitivity shift due to temperature change on electronics housing

xDT 420 x series $\pm 0,2\%$ full scale / 10 °C typ.
 xDT 460 x series $\pm 0,2\%$ full scale / 10 °C typ.

Diaphragm (in contact with media)

Maximum temperature at the diaphragm 400 °C

Zero shift due to temperature change on the diaphragm

xDT 420 x series $\leq 0,2$ bar / 10 °C typ.
 xDT 460 x series $\leq 0,4$ bar / 10 °C typ.

Sensitivity shift due to temperature change on the diaphragm

xDT 420 x series $\leq 0,1$ % f. s. / 10 °C typ.
 (35 and 50 bar $\leq 0,2$ % f. s. / 10 °C typ.)
 xDT 460 x series $\leq 0,4$ % f. s. / 10 °C typ.

3.10 EMC requirements

Conforming to **CE** in accordance with EMC directive.

Emitted interference DIN EN 50081-1
 (residential area)
 Immunity DIN EN 50082-2
 (industrial area)

3.11 Materials

Diaphragm 15-5PH Mat.No. 1.4545
 Armoloy coated
 Stem 15-5PH Mat.No. 1.4545

3.12 Mounting torque

max. 50 Nm (500 inch-lbs.)
 min. 12 Nm (100 inch-lbs.)

3.13 Environmental protection to IEC 529

PT housing IP54 (without connector)
 Standard connector
 PT06A-10-6S(SR) IP40
 Connector PT06W-10-6S IP64

3.14 Weight

1,1 kg

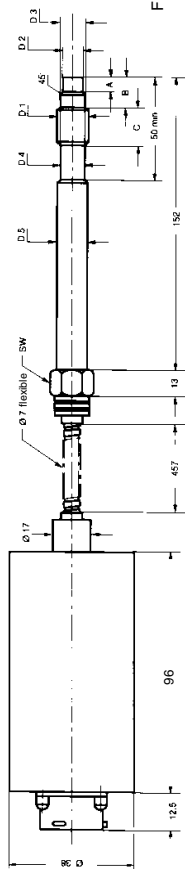

Fig. 02: MDT 422 X/462 X
with flexible stem

D1	D2	D3	D4	D5	A	B	C	SW
1/2"-20UNF-2A M18 x 1,5	7,8 ^{+0,05}	10,5 ^{+0,05}	11 ^{-0,5}	12,5	5,3 ^{+0,25}	11	16	16
	10 ^{+0,05}	16 ^{-0,1}	16 ^{-0,5}	18	6 ^{-0,25}	14	20	19

Operating manual

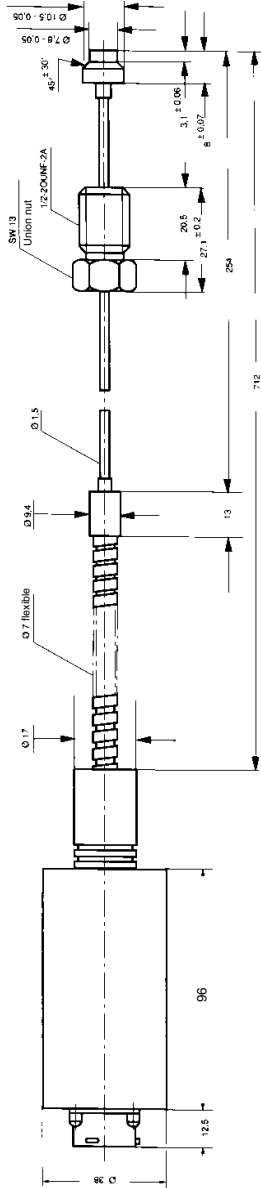

Fig. 03: MDT 435 x/467 x with capillary

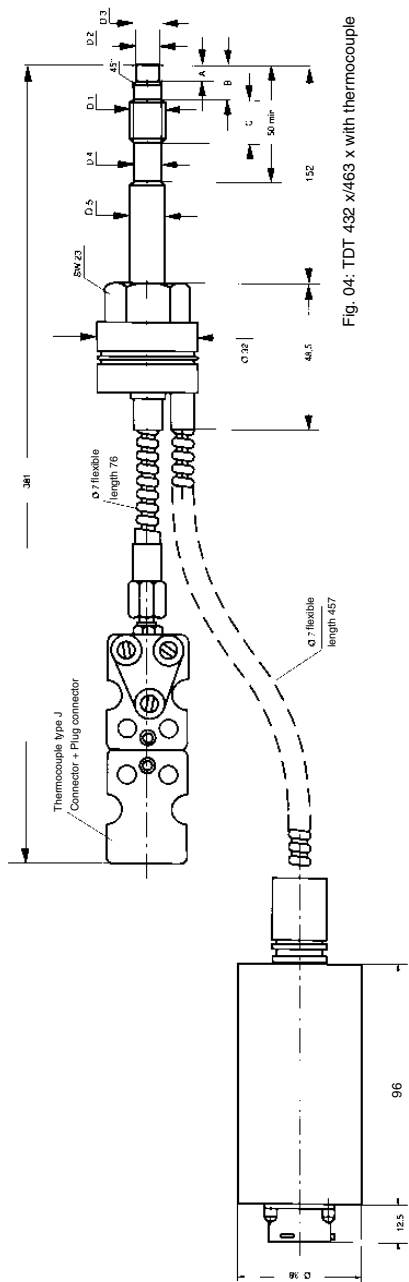

Fig. 04: TDT 432 x/463 x with thermocouple

D1	D2	D3	D4	D5	A	B	C	SW
1/2"-20UNF-2A	7,8 ^{+0,05}	10,5 ^{+0,05}	11 ^{-0,5}	12,5	5,3 ^{+0,25}	11	16	16
M18 x 1,5	10 ^{-0,05}	16 ^{-0,1}	16 ^{-0,5}	18	6 ^{-0,25}	14	20	19

Operating manual



4. Function

4.1	Construction	14
4.2	Description of functions	14
4.3	PT series	15

4.1 Construction

The PTs of series MDT 420 x/460 x are industry standard.

The main advantages are:

- manufactured under ISO 9001
- thermal stability
- resistance to aggressive media
- insensitivity to electromagnetic radiation (EMC)
- liquid-filled transmission system (mercury)
- pressure measurements in plastic melt up to a temperature of 400°C (750°F)
- maximum pressure 2000 bar

4.2 Description of functions

Through a closed, liquid-filled pressure transmission system, the PT furnishes an electrical signal that is proportional to the pressure of the melt.

The pressure applied by the medium is forwarded to the measuring diaphragm via the separating diaphragm and the mercury in the capillary. The deflection of the measuring diaphragm changes the resistance of the strain gauge bonded to the measuring diaphragm. The strain gauge is a Wheatstone bridge.

The integrated amplifier generates an electric mA signal in proportion to the applied pressure.



Fig. 05: Functioning principle of the PT of the MDT 420 x/460 x series

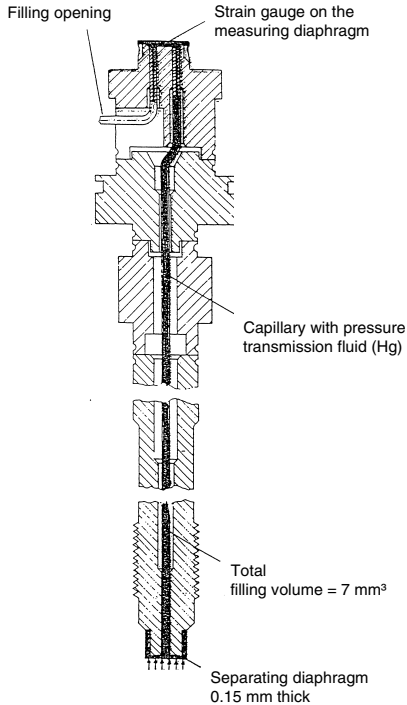

4.3 PT series

The MDT series PTs are also available as PT series. The PT types correspond to the MDT models, and the TPT types correspond to the TDT models; the number codes are identical. The PT series differs from the MDT series in that all specifications are given in US American units of measure.

E.g.:

- 1 bar = 14,5 PSI (PSI value is rounded)
- 2,54 cm = 1" (inch)

All other specifications are the same as in the MDT series.



5. Transport/delivery

5.1	Transport / packing / transport damage	16
5.2	Storage	16
5.3	Scope of delivery	16



Toxic hazard!

The PT contains a small amount (7 mm³) of mercury (Hg) as its transmission medium. If the diaphragm is damaged, mercury may escape.

Never transport or store the PT without the protective shell bolted in place. Remove the shell shortly before installation.

If mercury is inhaled or swallowed, seek medical attention immediately.

Mercury is hazardous waste and must be disposed of in accordance with applicable laws. **DYNISCO** will accept defective PTs.

If mercury escapes, use airtight packaging!

ATTENTION ESD sensitive component. Electrostatic discharge may damage the PT. Take ESD precautions.

5.1 Transport/packing/transport damage

- Do not let the PT be damaged by other items during transit.
- Use only the original packaging.
- Report transport damage to **DYNISCO** immediately in writing.

5.2 Storage

- Store the PT in original packaging only.
- Protect against dust and moisture.

5.3 Scope of delivery

- PT with diaphragm protection cap
- Cable socket
- Fastening clip (transmitter with flexible stem only)
- Calibration sheet
- Operating manual



6. Installation

6.1	Mounting hole	17
6.2	Checking the mounting hole	18
6.3	Mounting the Pressure Transmitter	19
6.4	Mounting PTs with flexible stem	20
6.5	Electrical connection	21
6.5.1	EMC / CE compliant connection	21
6.6	Connection assignments	22
6.7	Wiring	23
6.8	Connection thermocouple / RTD element	24

ATTENTION Ambient temperature for the electronics housing **max. +85°C**. Higher temperatures can result in damage and malfunctions. Mount the PT only in locations where these temperatures are not exceeded.

6.1 Mounting hole

ATTENTION To produce the mounting hole, use only **DYNISCO** machining tool kit.

- Drill the mounting hole as shown in figure 06.

Fig. 06: Mounting hole for transmitter
MDT 420 x, 460 x, 422 x, 462 x, 432 x, 463 x

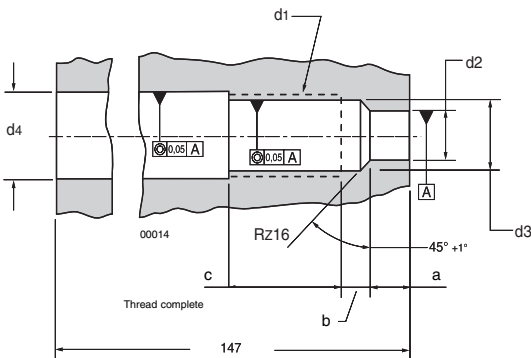

d_1	d_2	d_3	d_4	a	b	c
1/2"-20UNF-2B	$7,92^{+0,05}$	$11,5^{+0,1}$	13	5,7	4	19
M18 x 1,5	$10,1^{+0,05}$	$16,3^{+0,1}$	20	6,15	4	25



Fig. 07: Mounting hole for transmitter MDT467 x

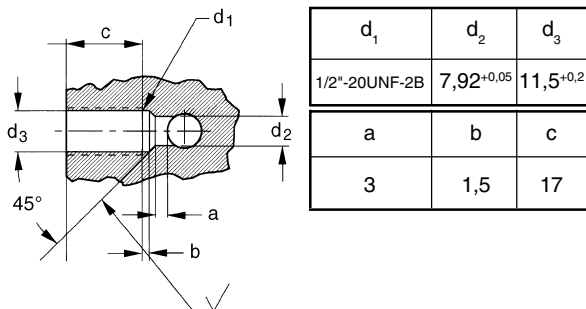

When reworking the mounting hole, pay particular attention to the centricity of:

- the hole,
- the thread and
- the sealing surface.

Pressure sealing takes place on the 45° beveled sealing surface and on the front cylindrical section of the PT (see figures 06 and 07).

The sealing surface must be:

- correctly machined
- free from marks and rough edges
- free from solidified plastic residue.

6.2 Checking the mounting hole

- Paint the test bolt **DYNISCO** on the marked area (figure 08, item 1) with marking ink up to the thread.

Fig. 08: test bolt with marking ink



- Insert the test bolt in the mounting hole
- Twist it in by hand until the two sealing surfaces make contact.
- Remove and examine the test bolt.

The only acceptable abrasion of marking ink is at the sealing edge (45°), evenly (!) over the entire circumference.

If the ink has been rubbed off in other places too:

- rework the mounting hole.



6.3 Mounting the Pressure Transmitter



Mounting and electrical connection of the PT must be done by specialists with EMC training, following all applicable regulations, and in **pressureless, voltage-free** condition with the **machine switched off**.

The machine must be secured against being switched back on!



Toxic hazard!

The PT contains a small amount (7 mm³) of mercury (Hg) as its transmission medium. If the diaphragm is damaged, mercury may escape.

Never transport or store the PT without the protective shell bolted in place. Remove the shell shortly before installation.

If mercury is inhaled or swallowed, seek medical attention immediately!

ATTENTION ESD sensitive component. Electrostatic discharge may damage the PT. Take ESD precautions.

ATTENTION Before mounting the PT, check the mounting hole carefully. The PT must only be mounted in holes that satisfy the requirements stipulated in chapter 6.1. A hole that does not satisfy these requirements can damage the PT.

ATTENTION Before mounting the PT, ensure that the mounting hole is free from plastic residue. Remove plastic residue with the **DYNISCO** cleaning tool kit. A test bolt is included with this cleaning set.

ATTENTION To prevent the PT from sticking permanently in the mounting hole, coat the thread section of the transmitter with high temperature resistant grease or a suitable parting agent.

- Check the mounting hole with the test bolt, and clean with cleaning set if necessary.
- Coat the thread section of the transmitter with high temperature resistant grease or a suitable parting agent.

ATTENTION Always use a spanner applied to the designated hexagon collar when screwing the PT in and out. Do not apply the tool to the housing or housing/sensor connection!



ATTENTION Maximum mounting torque **50 Nm**.
If the mounting torque is too high, the PT may be damaged or its zero point may shift.

- screw the PT into the mounting hole and tighten.

6.4 Mounting PTs with flexible stem

Mounting a PT with a flexible stem to the pressure sensor is done analogously to the procedure in 6.3.

ATTENTION Avoid kinking or crushing the flexible stem.

Minimum bending radius

- **25 mm** for protected capillary
- **2 mm** for unprotected capillary
(MDT 435 x / 467 x)

The connector must be easily accessible.

- Mount the electronics housing of the PT with the fastening clip **DYNISCO** P/N 200982 (included). See mounting example in figure 09.
- Additionally secure the flexible stem between the electronics housing with a standard cable clip.

Fig. 09: Mounting example for Pressure Transmitter with flexible stem

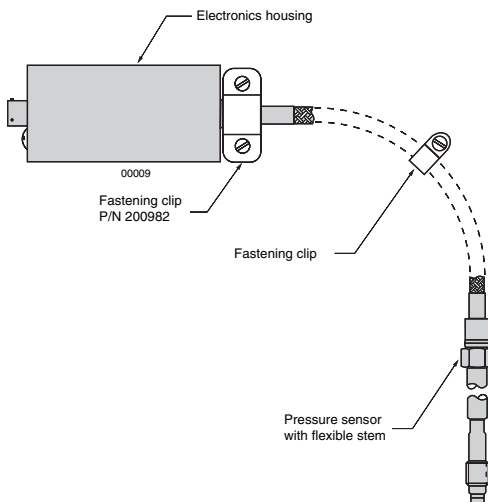



6.5 Electrical connection



The PT may only be assembled and electrically connected by an EMC-trained specialist in accordance with applicable regulations, in a **de-pressurized, de-energized state, with the machine switched off.**

The machine must be safeguarded from being switched on inadvertently!

The 2-wire amplifier has been developed with due consideration for the harshest industrial conditions.

However, in spite of these qualities, a power unit designed for EMC conformance must be used for the power supply. The electrical connection must be executed in conformance with EMC requirements.

ATTENTION If the electrical connection is not executed as described in Chapter 6.5.1, or if cable/cable sockets / PG couplings other than those prescribed by **DYNISCO** are used, then **DYNISCO** cannot warrant compliance with EMC requirements.

6.5.1 EMC / CE-conformant connection

- Ground the machine element with the mounting hole for the PT, as prescribed by regulation. The PT must be connected to the ground via the mounting hole.
- The use of shielded cable is not necessary. If shielded cable is used, then shield the connecting cable on both sides in an EMC-conformant manner.
- When introducing the connecting cable, (for instance into an EMC-conformant control cabinet), the shielding must be laid out on the conductive enclosure in an EMC-conformant manner, or it must be routed via an installed cable socket/ cable plug, which likewise is connected with the conductive enclosure.
- Connect unused cable core or free cable ends properly to Gnd on one side.

See Chapter 9, Accessories, for order numbers of the EMC-conformant cable sockets required for the PT connection.



6.6 Pin assignment

Standard model MDT 4xx x-xxx-xx:

Connector: 6-pin male,
Bendix PT02A-10-6P
Cable socket: PT06A-10-6S(SR)

Fig. 10: 6-pin female connector

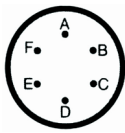

Top view solder side

PIN	Designation
A	signal (+)
B	signal (-)
C	do not connect
D	autozero
E	calibration shunt 80%
F	common autozero/cal

The connector housing is connected conductively to the housing of the PT.

6.7 Wiring

Fig. 12a: Wiring proposal 2-wire mA, floating mA indication with internal resistor $R_i < 44 \times U_s - 380$

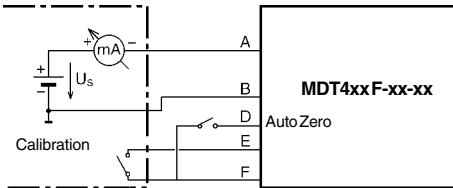
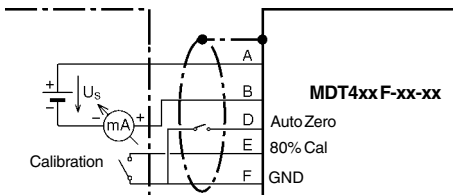

Fig. 12b: Wiring proposal 2-wire mA, mA indication with internal resistor $R_i < 44 \times U_s - 380$





6.8 Connection thermocouple/RTD element (optional) MDT / TPT series

Fig. 15: Thermocouple connection

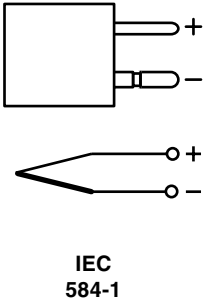
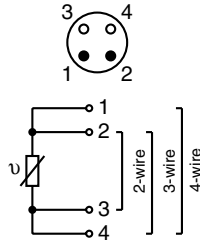

Fig. 16: RTD connection





7. Commissioning

7.1	Supply voltage	25
7.2	Calibration	25
7.3	Zero adjustment	26
7.4	Operation	26

ATTENTION Before putting the PT into operation, make sure the PT is securely mounted and sealed.

7.1 Supply voltage

ATTENTION Using a supply voltage which is different from that stated in the technical specifications or has reversed polarity can damage the PT or cause it to malfunction.

7.2 Calibration

It is not necessary to calibrate the PT, as the PT has already been calibrated in the factory.

PTs of series MDT 420 x/460 x have an internal calibration signal. Connecting terminals E and F switches the calibration signal to the signal output. It is 80% of the full scale pressure of the transmitter.

ATTENTION Calibrate in pressureless state and at room temperature. Other ambient temperatures will corrupt the signal. Use an adjustment screwdriver!

ATTENTION Do not change the installed position of the PT after calibration. If the position is changed you must re-calibrate the PT.

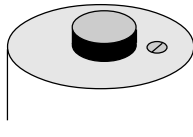

Fig. 17: Electronics housing lid

7.3 Zero adjustment

Use the button in the lid of the electronics housing for adjustment.

For MDT series PT reset 420 x/460 x zero at operating temperature!

- Remove cover screw.
- PT must be depressurized.
- Wait until a constant operating temperature is set on the pressure transducer.
- Auto zero via the button on the housing, or externally via contacts D + F. To do this, depress the button for one second. Zero-balancing will be executed after the button is released.
- Refasten the cover screw on the lid.

7.4 Operation

ATTENTION Before starting the machine, wait until the melt medium at the diaphragm of the PT has reached its operating / processing temperature. If the machine is started before the medium reaches its operating temperature, the PT will be damaged. If it is hard to tell when the operating temperature has been reached, use a combined TDT PT with thermocouple.

ATTENTION Operating temperature at the PT diaphragm **max. 400 °C (750 °F)**. Higher temperatures will damage the PT.

ATTENTION Ambient temperature for the electronics housing **max. +85°C**. Higher temperatures can result in damage or malfunctions. Mount the PT only in locations where this temperature is not exceeded.



8. Maintenance

8.1	Maintenance	27
8.2	Thermocouple replacement TDT models	28
8.3	Repair/disposal	29

8.1 Maintenance



Mounting and electrical connection of the PT must be done by specialists with EMC training, following all applicable regulations, and in **pressureless, voltage-free** condition with the **machine switched off**.

The machine must be secured against being switched back on!



Burn hazard!

The PT must be removed with the melt in molten condition. The PT can be very hot when removed.



Wear protective gloves!

ATTENTION ESD sensitive component. Electrostatic discharge may damage the PT. Take ESD precautions.

ATTENTION Always remove the PT before cleaning the machine with abrasives or steel wire brushes or suchlike.

ATTENTION Before removing the PT, the medium must be in molten condition.

ATTENTION Removing the transmitter with the medium in solidified condition can damage the diaphragm of the PT.

ATTENTION Do not clean the screw-in section of the PT with hard objects. This will damage the PT!

ATTENTION Always use a spanner applied to the designated hexagon collar when screwing the PT in and out. Do not apply the tool to the housing or housing/sensor connection!

- Remove the PT.
- Carefully clean the diaphragm of the transmitter with a soft cloth, while the medium is still malleable.



8.2 Thermocouple replacement TDT models

A defective thermocouple is easy to replace.

- Loosen the hexagon socket screw at the top end of the sensor stem.
- Remove the defective thermocouple from the probe stem.

ATTENTION When fitting the new thermocouple, the pressure transmitting capillary must be located in the slot of the thermocouple.

- Insert the new thermocouple all the way into the probe stem.
- Tighten the hexagon socket screw at the top of the sensor stem to secure the thermocouple.

Fig. 18: Thermocouple

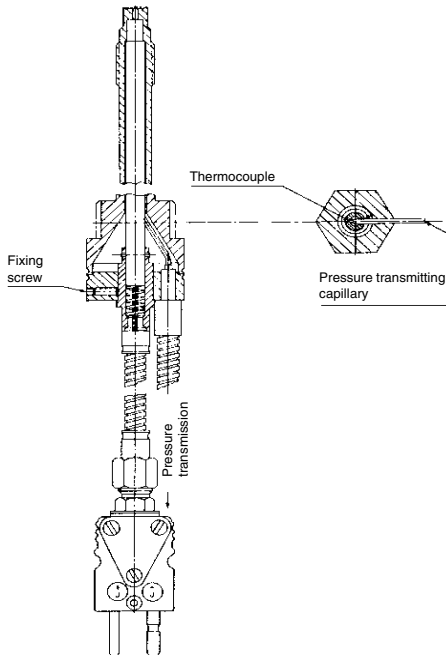



8.3 Repair/disposal



Toxic hazard!

The PT contains a small amount (7 mm³) of mercury (Hg) as its transmission medium. If the diaphragm is damaged, mercury may escape.

Never transport or store the PT without the protective shell bolted in place. Remove the shell shortly before installation.

If mercury is inhaled or swallowed, seek medical attention immediately!

Mercury is hazardous waste and must be disposed of in accordance with applicable laws. **DYNISCO** will accept defective PTs.

If mercury escapes, use airtight packaging!

Please send defective PTs to your **DYNISCO** representative.

For addresses, see the back cover of the operating manual.



9. Accessories

- Machining tool kit ½"-20UNF-2A P/N 8BRD0004
- Machining tool kit M18 x 1,5 P/N 8BRD0005
- Cleaning tool kit ½"-20UNF-2A P/N 8BRD0009
- Cleaning tool kit M18 x 1,5 P/N 8BRD0006
- Pressure sensor simulator
- Pressure sensor calibrating device

Connectors, Cable glands, Cable

Designation	Order No.
Female connector DIN 7.pin	E311 0035
Female connector Bendix	E311 0029
Cable gland PG 7 CE	E447 0037
Connecting cable VT 460 - 6 meter	9VT0 0017
Connecting cable VT 460 - 10 meter	9VT0 0018
Connecting cable VT 420 - 6 meter	9VT0 0005
Connecting cable VT 420 - 10 meter	9VT0 0007



10. Troubleshooting

10.1 Troubleshooting

31

10.1 Troubleshooting

Fault	Possible cause	Resolution
No signal	Cable breakage or poor contact	Check cable and contact, or replace
	No supply voltage	Check supply voltage
Strong zero shift when screwing in	Mounting hole incorrectly produced (alignment error)	Check hole with test bolt (chapter 6.2), rework with tool if necessary
	Mounting torque too high	Adjust to max. 50 Nm mounting torque
No signal change despite pressure rise	Plug forming in front of diaphragm	Check mounting hole; remove solidified plastic
	Diaphragm damaged	Send pressure transmitter to DYNISCO for repair



11. Declaration of Conformity

EC – DECLARATION OF CONFORMITY

As defined by EU Electromagnetic Compatibility Directive 89/336 EEC

The electronic assembly

Type/Designation: Pressure transducer

Type: MDT 2-wire technology 4-20mA

is developed, constructed, and produced in accordance with EU Directives 89/336/EEC, 93/68/EEC, 93/44/EEC. Conformity with the directives is the sole responsibility of:

Dynisco Europe GmbH
Wannenäckerstr. 24
D-74028 Heilbronn

The following harmonized standards apply:

DIN EN 61000-6-3:2001	Electromagnetic compatibility (EMC) – Emitted Interference, Part 1: Residential
DIN EN 61000-6-2:2001	Electromagnetic compatibility (EMC) – Interference Resistance, Part 2: Industry

The following national standards, directives, and specifications apply:

EN 61000-4-2:1995 + A1:1998 + A2:2001; EN 61000-4-3:2002 + A1:2002;
EN 61000-4-4:1995 + A1:2001 + A2:2001; EN 61000-4-5:1995 + A1:2001;
EN 61000-4-6:1996 + A1:2001; EN 55022:1998 + A1:2000

Complete technical documentation is available. The operating manual pertaining to the device is available

In the original version: German
In the national language of the user: English

Heilbronn, April 8th 2004

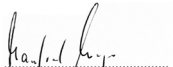
.....
Manfred Wege, Geschäftsführer



Visit us
in the world wide web:

Dynisco Instruments
38 Forge Parkway
Franklin, MA 02038
USA

Tel: +1 508 541 9400
Fax: +1 508 541 9437
Email: InfoInst@dynisco.com

Dynisco UK Ltd.
Silver Birches Business Park
Aston Road, Bromsgrove
Worcestershire B60 3EU
Great Britain

Tel: +44 1527 577077
Fax: +44 1527 577070
Email: DyniscoUK@dynisco.com

Dynisco Extrusion
1634 Tate Blvd. S.E.
Hickory, NC 28602-4244
USA

Tel: +1 828 326 9888
Fax: +1 828 326 8882
Email: InfoExtr@dynisco.com

Dynisco SPOL, S.R.O.
cp. 579
756 55 Dolni Becva
Czech Republic

Tel: +42 0571 647228
Fax: +42 0571 647224
Email: Dyniscocz@nexta.cz

Dynisco Europe GmbH
Wannenäckerstraße 24
74078 Heilbronn
Deutschland

Tel: +49 7131 2970
Fax: +49 7131 23260
Email: DyniscoEurope@dynisco.com

Dynisco B.V.
Muziekplein 67
PO Box 666
NL-5400 AR Uden
The Netherlands

Tel: +31 413 250665
Fax: +31 413 260548
Email: Dynisco-BV@dynisco.com

Dynisco Instruments S.a.r.l.
466, rue du Marché Rollay
94500 Champigny sur Marne
France

Tel: +33 1 4881 8459
Fax: +33 1 4881 8334
Email: DyniscoFrance@dynisco.com

Dynisco.s.r.l.
Via Adriatico, 2/2
20162 Milano
Italia

Tel: +39 02 661 01733
Fax: +39 02 661 02908
Email: Dyniscoltaly@dynisco.com



www.dynisco.com

Technische Änderungen vorbehalten
Technical subject to change
Sous réserve de modifications techniques
Con riserva di modifiche tecniche

9LIT0221 05/2004