

Industriefunkuhren



Technical Manual

General System Information

Antenna Equipment GPS

ENGLISH

Version: 01.03 – 26.01.2005

Downloading Technical Manuals

All current manuals of our products are available free of charge via our homepage on the Internet.

Homepage: <http://www.hopf.com>

E-Mail: info@hopf.com

Symbols and Characters



Operational Reliability

Disregard may cause damages to persons or material.



Functionality

Disregard may impact function of system/device.



Information

Notes and Information.



Safety regulations

The safety regulations and observance of the technical data serve to ensure trouble-free operation of these devices and protection of persons and material. It is therefore of utmost importance to observe and compliance with these regulations.

If these are not complied with, then no claims may be made under the terms of the warranty and no liability will be assumed for any ensuing damage.



Safety of the device

These devices has been manufactured in accordance with the latest technological standards and approved safety regulations

These devices should only be put into operation by trained and qualified staff. Care must be taken that all cable connections are laid and fixed in position correctly. The devices should only be operated with the voltage supply indicated on the identification label.

The devices should only be operated by qualified staff or employees who have received specific instruction.

If a device must be opened for repair, this should only be carried out by employees with appropriate qualifications or by **hopf** Elektronik GmbH.

Before a device is opened or a fuse is changed all power supplies must be disconnected.

If there are reasons to believe that the operational safety can no longer be guaranteed the device must be taken out of service and labelled accordingly.

The safety may be impaired when a device does not operate properly or if it is obviously damaged.

Contents	Page
1 How GPS works	7
2 Accessories.....	8
2.1 GPS Antenna	8
2.1.1 Where to install the antenna	8
2.1.2 Mechanical Structure of the Antenna.....	8
2.1.3 Electrical Structure of the Antenna	8
2.2 Antenna Cable.....	9
2.2.1 Cable Length and Cable Types	9
2.2.2 Preparation of the cable	9
2.2.3 Cable Installation.....	10
2.3 Lightning Protection.....	11
2.3.1 General Information about Lightning Protection	11
2.3.2 Causes of Overloading	11
2.3.2.1 Electrostatic Field	11
2.3.2.2 Increase in the Earth Potential.....	11
2.3.2.3 Electromagnetic Radiation	11
2.3.3 Lightning Protection Concept.....	12
2.3.3.1 Rough Lightning Protection.....	12
2.3.3.2 Fine Protection (in the hopf GPS receiver board)	12
2.3.3 Installation	12
2.4 Line Amplifier.....	13
2.4.1 Installation	13
2.5 Dual Power Splitter (Operation of two Appliances on one Antenna)	14
2.5.1 Installation	14
2.5.2 Outside Connection.....	14
2.6 8x Power Splitter (Operation of eight Appliances on one Antenna).....	14
3 Technical Data	15

4 Appendix	17
4.1 A01 - World Time Zone Map.....	17
4.2 A02 - Method of Mounting for Outdoor Antennas GPS DCF77	18
4.3 A03 - Mounting of Antenna 4490G10 / 441800A	19
4.4 A04 - Dimensions of Antenna 4490G10 / 441800A.....	20
4.5 A04a - Dimensions of Antenna 4490G11 / 441700A.....	21
4.6 A05 - Mounting Bracket for Antenna 4490G10 / 441800A	22
4.7 A06 - GPS Reception in 3D and Position Fixed Mode	23
4.8 A07 - GPS antenna cabling for max. 25m (82 ft) cable	24
4.9 A08 - GPS antenna cabling for max. 100m (328 ft) cable	25
4.10 A09 - GPS antenna cabling for max. 200m (656 ft) cable	26
4.11 A10 - GPS antenna cabling for max. 325m (1066 ft) cable	27
4.12 A11 - GPS antenna cabling for Power Splitter 4443 (Configuration 1)	28
4.13 A12 - GPS antenna cabling for Power Splitter 4443 (Configuration 2)	29
4.14 A13 - Assembly of RG59 cable.....	30
4.15 A14 - Assembly of low loss LSZH* cable	31
4.16 A15 - Dimensions of Lightning Protector.....	32
4.17 A16 - Dimensions of Line Amplifier	33
4.18 A17 - Dimensions of GPS Power Splitter	34

1 How GPS works

At a height of about 20,000km satellites circle around the earth twice a day on 6 different orbits and angles (see picture below).

The GPS system¹ was developed on the basis of 18 satellites with 3 in reserve. In the course of time this number was increased to 24 plus 3 in reserve to cover possible short-term breaks in coverage. Therefore 6 to 11 satellite are visible from any point on earth at all times. On board each satellite there is a highly accurate atomic clock (accuracy at least 1×10^{-12}).

A basic frequency of 10.23 MHz is derived from the frequency of the atomic clocks. The two carrier frequencies L1 and L2 are produced from this basic frequency.

- transmission frequency L1 = $154 \times \text{basic frequency} = 1575.42 \text{ MHz}$
- transmission frequency L2 = $120 \times \text{basic frequency} = 1227.60 \text{ MHz}$

Every satellite broadcasts by modulation all the important navigation and system data on these two carrier frequencies. The data of the frequency L1 may be decoded for civil purposes. The exact time can be calculated from these data and the position defined via the antenna.

The GPS antenna receives signals from all the satellites visible above the horizon and passes them on to the GPS receiver through a coaxial cable. Four satellites are required for continuous time decoding.

The GPS world-time UTC² is calculated by subtracting the leap seconds from the GPS world-time (GPS-UTC). At present (JAN 1999) world-time lags 13 seconds behind GPS-UTC. The difference is not constant, but changes with every insertion of a leap second.

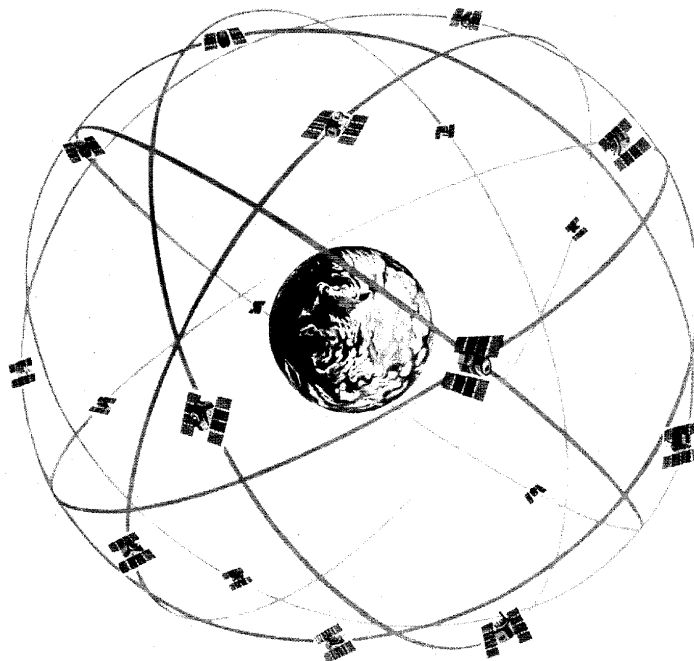

¹ GPS = Global Positioning System

² UTC = Universal Time Coordinated

2 Accessories

2.1 GPS Antenna

Due to the small signal level an outdoor installation of the antenna is recommended.

2.1.1 Where to install the antenna

Since the antenna is designed to receive data from all directions it must be non-directional. Because of the high frequency there must be "visual contact" to the satellites.

Visual contact means that no solid or large objects (buildings) may block the view to the horizon (see drawing **A06** "GPS Reception in 3D and Position Fixed Mode"). Rain, fog and clouds as well as small objects, e.g. chimneys, at a certain distance may impair the view minimally.



The larger the visible section of the sky, the longer the post-connected electronics remain radio-synchronous.

In the standard reception mode (3D) of the GPS system reception from at least 4 satellites is necessary. In position fixed mode reception from only one satellite is necessary (see technical description of GPS system). It is also possible to install the antenna behind a non-coated window.

No additional voltage supply is required to operate the antenna. It is provided via the antenna cable and is supplied by the BNC connector of the **hopf** GPS system.

2.1.2 Mechanical Structure of the Antenna

The antenna is housed in a round weatherproof plastic casing. The casing cover is arched to prevent any rain water, snow or other impurities from settling on the antenna.

The mechanical construction (see drawing **A04** "Dimensions of Antenna 4490G10 / 4418A") consists of sturdy, anodized aluminium or aluminium die-casting and is designed to resist high winds.

The plastic housing can be installed horizontally as well as vertically to the mechanical parts (see drawing **A03** "Mounting of Antenna 4490G10 / 4418A"), allowing both wall and flat-roof installation of the antenna. The antenna cable can be fed either through the base or through a slot on the side of the mounting flange.

2.1.3 Electrical Structure of the Antenna

As the antenna is non-directional, reception cannot be improved by mechanical shaping as, for example, with parabolic antennas. Therefore the signal strength at the antenna input is about 1×10^{-16} Watts and already below the generally permitted noise level.

An extremely low-noise pre-amplifier is placed behind the antenna in order to feed the signals to the electronics via an antenna cable. The antenna cable also supplies the voltage to the pre-amplifier.

2.2 Antenna Cable

2.2.1 Cable Length and Cable Types

The cable length is restricted because of the high frequency and the low signal strength. It can be lengthened by using a repeater. At present two different types of cables are available allowing the following distances between antenna and electronics to be bridged:

- Cable length up to max. 25 m (82.0 ft): Using standard cable ring KA4017
- Cable length over 25 m (82.0 ft): Using **hopf** LSZH cable KA110109



The combination of different cable types within one antenna configuration is **not** possible.

hopf low loss LSZH¹ cable KA110109 replaces **hopf** GPS special cable KA110107. The BNC connectors ST001106 used for **hopf** GPS special cable KA110107 are also suitable for the new **hopf** low loss LSZH cable KA110109.

Antenna cable	length	see
Standard cable RG59, supplied on a coil:	max. 25 m (82.0 ft)	(A07)
hopf low loss LSZH cable <u>without</u> line-amplifier 6849:	max. 100 m (328.0 ft)	(A08)
hopf low loss LSZH cable with <u>one</u> line-amplifier 6849:	max. 200 m (656.0 ft)	(A09)
hopf low loss LSZH cable with <u>two</u> line-amplifiers 6849:	max. 325 m (1,066.0 ft)	(A10)
hopf low loss LSZH Kabel <u>without</u> line-amplifier 6849 <u>with</u> power splitter 4443 (Configuration 1):	max. 75 m	(A11)
hopf low loss LSZH Kabel <u>without</u> line-amplifier 6849 <u>with</u> power splitter 4443 (Configuration 2):	max. 75 m	(A12)

A maximum of two line amplifiers can be used.



For antenna systems deviating from the above-listed configurations (e.g. modules and cable lengths) clarification based on the required cable length is necessary.

2.2.2 Preparation of the cable

Because of the high frequency and the signals below the permitted noise level, special attention must be paid to preparation of the cable. If the cables are not prepared correctly this could impair reception.

When antenna systems are ordered with cables prepared by **hopf** the whole system is factory-tested for reception.

For preparation of the antenna cable by the customer refer to: **A13-A14**.

¹ LSZH: **L**ow **S**moke **Z**ero **H**alogen

2.2.3 Cable Installation

When laying the cable special attention must be paid to the following points:

- The coaxial connectors should not be damaged or soiled. The connections should be protected with plastic foil.
- The bending radius of the cable must not be less than 50 mm.
- No section of the cable should be squeezed nor should the insulation coating be damaged

The cable is fed through the antenna base and connected to the antenna via a coaxial connector. To lay the cables this can be disconnected. To do this the Allan screws on the antenna base are removed and the dish is lifted off.



The cable must not be installed in the vicinity of other HF-, control or power cables.

The emitted radio interference from these cables may interfere with GPS reception because of the extremely low reception power.

2.3 Lightning Protection

2.3.1 General Information about Lightning Protection

When outdoor antennas are used high interference voltage or current pulses may occur in the antenna cable during thunderstorms. This may result in damaging or destroying not only the directly connected radio-controlled clock system but also any other devices connected.

To avoid severe damage and damage-related costs an indirect lightning protection should be installed between the outdoor antenna and the circuit board of the radio-controlled clock (see drawing **A15** "Dimensions of Lightning Protector").

2.3.2 Causes of Overloading

Buildings can be protected with the aid of the lightning conductor developed by Benjamin Franklin. This though does not, however, protect the electronic devices inside from indirect consequences of lightning.

A flash of lightning is simply an excessive short circuit of two lines with different potentials. When lightning occurs these two lines are usually two layers of cloud or one layer of cloud and the earth. Then a current of 1000 to 100000 ampere circulates between the two layers of cloud or between the earth and the clouds. On unprotected devices connected to open lines (antenna, antenna cable) this results in the following forms of indirect interference or destructive influence.

2.3.2.1 Electrostatic Field

The increase of the electrostatic field up to 50 kV/m can be caused by the vicinity of potential-loaded thunder clouds or by the static charging of the air. Field changes take place suddenly creating high-frequency, electromagnetic micro-pulses.

2.3.2.2 Increase in the Earth Potential

When lightning strikes into the ground this causes a sudden increase in the earth potential which depends on the power of the current and on the local specific resistance of the earth. This overloading is reduced undulatorily through the ground and this causes high voltage-potential differences in unprotected devices.

2.3.2.3 Electromagnetic Radiation

The flash of lightning may be compared to an antenna of several kilometres length. The pulse current of several kiloamperes radiates a strong electromagnetic field. This radiation induces high voltages and currents in "neighbouring" lines (1 to 2 km) which can also cause overloading in connected devices.

2.3.3 Lightning Protection Concept

Overloading caused by the indirect effects of lightning cannot be avoided, but devices can be protected against its destructive consequences.

To reduce overloading as quickly as possible it is necessary to short-circuit the lines. When the problem is solved the device should return to its original specifications.

This is why the **hopf** lightning strategy is made up of a combination of rough and fine protection.

2.3.3.1 Rough Lightning Protection

The double-chamber gas arrester, located in the lightning protection, has a dynamic operating voltage of < 700 V and conducts voltage, when ignited, out of the cable to the earth potential.

2.3.3.2 Fine Protection (in the **hopf** GPS receiver board)

Fast absorber diodes with a response time of < 1 nsec. and an absorber power of 600 W at the input of the GPS receiver board keep the potential differences between antenna core and zero at a constant approximate ± 6 V until ignition of the double-chamber gas arrester.

Because of the high frequency and the signals below the permitted noise level, the elements must be set up in strip-line sequence.

This combination also guarantees the potential separation of the antenna circuit to other electronics in conditions without interference.



If no further devices (eg. power splitter) are installed between lightning protection and electronic with fine protection, for safety reasons a maximum cable length must not be exceeded (see also drawings of cable configuration **A07 - A10** in the appendix of this description).

2.3.3 Installation

When **hopf** lightning protection is used it is assumed that at the location there is a comprehensive lightning protection concept, including direct lightning protection of the building according to VDE and a lightning-protected voltage supply to the devices.

The antenna is connected to the "**Antenna / Antenne**" BNC connector, and the extended cable to the electronics on the connector marked "**Receiver / Empfänger**".

It is important that the earth line of the connected device has the same earth connection point as the lightning protection, so that no destructive potential differences can arise.

Earth wire:

The earth wire may not exceed a maximum length (see also drawing **A02** "Method of Mounting for Outdoor Antennas GPS / DCF77" in the appendix of this description).



Only trained personnel may install the lightning protection.

2.4 Line Amplifier

For positioning and required quantity of line amplifiers see Appendix **A09-A10**.

2.4.1 Installation

The line amplifier (see drawing **A16** "Dimensions of Line Amplifier") is integrated into an HF-proof housing with a base plate. It is therefore easy to fix the device to the wall.

Refer to **chapter 2.2.1 Cable Length** to find out for which lengths of cable it is necessary to use the 6849 line amplifier.

The 6849 line amplifier is looped into the antenna cable. The voltage supply of the line amplifier is provided via the antenna cable by the BNC connector of the **hopf** GPS system.

The GPS antenna cable from the antenna is connected to the BNC connector "**ANTENNA**". The signal is supplied to the connected **hopf** GPS system by the BNC connector "**RECEIVER**".



To avoid destruction caused by overloading ensure that the line amplifier is not earthed.

The integrated fine protection of the line amplifier enables installation **before** the lightning protection without any risk of destroying the line amplifier through overloading.

2.5 Dual Power Splitter (Operation of two Appliances on one Antenna)

The passive Power Splitter 4443 is used to separate the antenna signal into two equally strong signals to minimize the loss while operating two **hopf** GPS systems on one antenna. The power splitter also serves to decouple the external voltage supply on the internal conductor of the antenna.

2.5.1 Installation

The Power Splitter (see drawing **A17** "Dimensions of GPS Power Splitter") is mounted in a HF-proof housing with an insulated base plate. The unit can therefore be easily screwed to the wall near the GPS systems. The antenna is connected to the single BNC-connector called "**Antenna in**". On the opposite side of the housing there are the two antenna outputs to the GPS systems.

The voltage supply of the power splitter is provided via the antenna cable and is supplied by the "**GPS in**" BNC connector of the **hopf** GPS system.



The power splitter may not be connected to earth to avoid damage by overvoltage.

The integrated fine protection of the power splitter enables installation before the lightning protection without any risk of destroying the power splitter through overloading.



A free output port should be closed with a HF resistor of 50 Ω .

2.5.2 Outside Connection

It is also possible to connect a foreign GPS-system to a free splitter output. Care must be taken that the external power supply of the alien device for the antenna lies within the permitted voltage range (refer to technical data). The outside device must also be able to evaluate the original GPS signal in the L1 band.

2.6 8x Power Splitter (Operation of eight Appliances on one Antenna)

Also an 8x power splitter is disposable by the **hopf** company. Take contact to us to get more information about this power splitter .

3 Technical Data

Antenna 4490

Type of antenna:	micro-strip-line with pre-amplifier
Mean frequency:	1575.42 MHz
Band width:	10 MHz
Angle of view:	+ 10° above the horizon
Impedance:	50 Ohm
Power amplification:	20 dB
Voltage supply via the antenna cable:	4.5 - 7V DC
Temperature range:	
• Operation:	-30° C to +85° C
• Storage:	-40° C to +85° C
Humidity:	100%
Protection class:	IP65
Category of application	outdoors
MTBF:	> 500,000 h ¹

Lightning Protection 4495

Housing:	aluminium die-cast housing
Dimensions of housing:	250 x 105 x 95 mm
Input / output:	BNC-connector
Earth connection point:	screw connection M6
Weight:	approx. 1.8 kg
Operating speed:	< 1ns
Current surge pulse 8/20 µs wave form:	10 kA
Protection level at 6 kV 1,5/50 µsec. wave at input:	< 12 V
Input impedance:	50 Ω
Insertion loss:	max. 3 dB
Temperature range:	
• Operation:	-20° C to +80° C
• Storage:	-40° C to +85° C
Humidity:	95% not condensed
Protection class:	IP40
Category of Application	indoors, protected
MTBF:	> 10,000,000 h ²



Outdoor antennae and lightning protection can be destroyed by lightning. We can therefore provide only a limited guarantee for these parts.

¹ Equipment may be damaged by lightning - mentioned values are only theoretical values.

² Lightning protector excluded guarantee.

Line Amplifier 6849

Impedance:	input / output 50 Ω
Frequency range:	1575 MHz
Band width:	\pm 50 MHz
Power amplification:	min. 20 dB
Voltage supply via the antenna cable:	4.5 - 7V DC
Weight:	approx. 0.13 kg (1.8 kg with protection housing)
Temperature range:	
• Operating:	-20° C to +80° C
• Storage:	-40° C to +85° C
Humidity:	95% not condensed
Protection class:	IP50
Category of application	indoors, protected
MTBF:	> 10,000,000 h

Power Splitter 4443

Operating frequency:	1575 MHz
Insertion loss (S21, S31):	max. 1 dB
Input reflection damping (S11):	22 - 26 dB
Output reflection attenuation (S22,S33):	20 - 26 dB
Output insulation (S23):	23 - 27 dB
Amplitude stability (output):	0.05 - 0.15 dB
VSWR (input):	min. 1 : 1.17 dB
External current:	max. 50 mA
Temperature range:	
• Operating:	-20° C to +80° C
• Storage:	-40° C to +85° C
Humidity:	95% not condensed
Protection class:	IP50
Category of application:	indoors, protected
MTBF:	> 10,000,000 h

World Time Zone Map (Difference Time to UTC)

Unterteilung der Zeitzonen (Differenzzeit zu UTC)

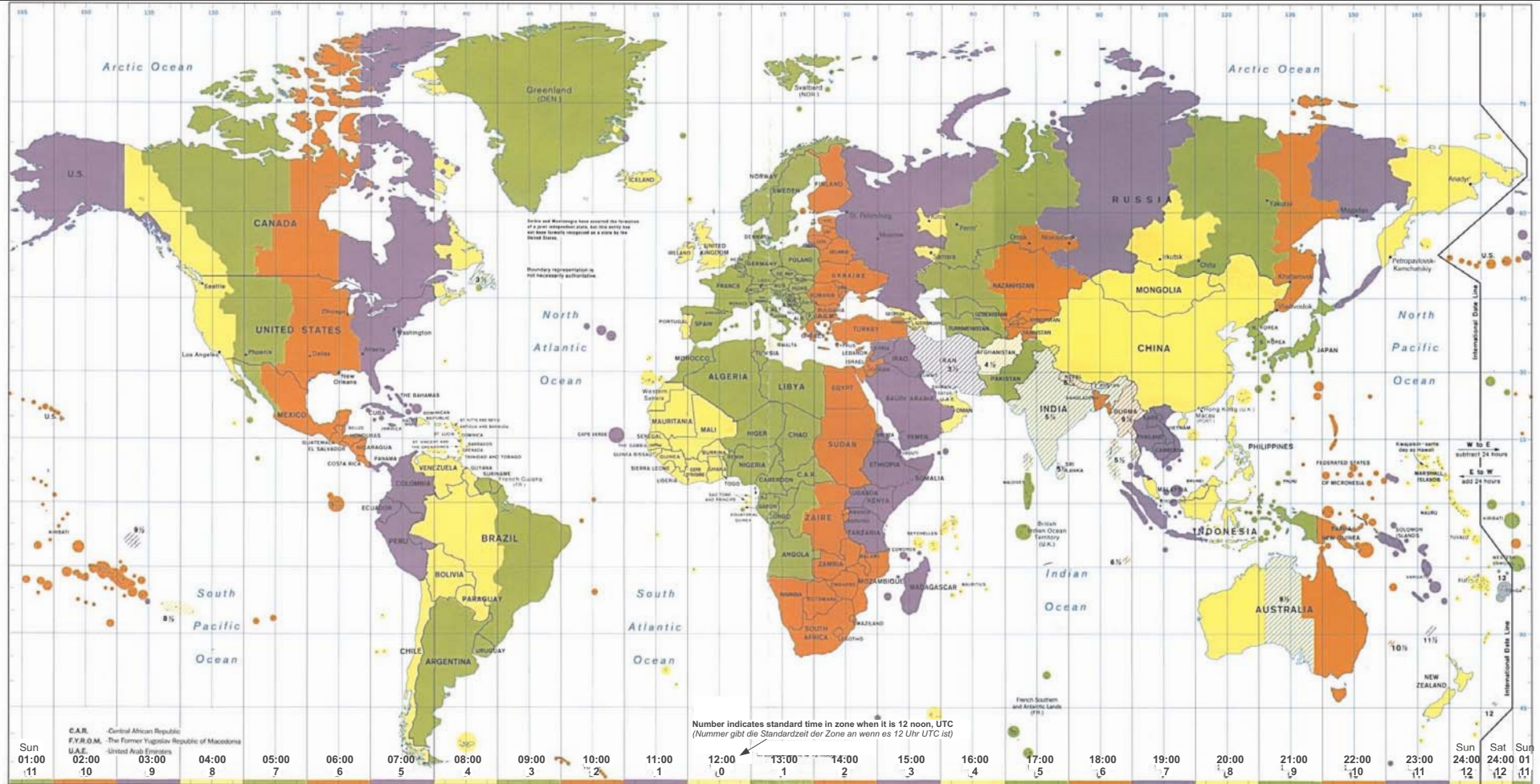

WEST
 Add time zone number to local time to obtain UTC. Subtract time zone number from UTC to obtain local time.
 (Addiere Zeitzone-nr. zu lokaler Zeit um UTC zu erhalten. Subtrahiere Zeitzone-nr. von UTC um lokale Zeit zu erhalten.)

EAST
 Subtract time zone number from local time to obtain UTC. Add time zone number to UTC to obtain local time.
 (Subtrahiere Zeitzone-nr. von lokaler Zeit um UTC zu erhalten. Addiere Zeitzone-nr. zu UTC um lokale Zeit zu erhalten.)

Universal Time Coordinated (UTC)
 formerly (vornals)
 Greenwich Mean Time (GMT)

changes	drawing number	ZC01091101	page
	World Time Zone Map (Difference Time to UTC)		
	date	11.09.01	System
	name	Vollmer	
	check		
date	changes	name	size
			A4

post box 1847
 D-58468 Lüdenscheid
 fon: (02351) 938686
 fax: (02351) 459590

Method of Mounting for Outdoor Antennas GPS / DCF77

Montagearten Außenantennen GPS / DCF77

4490G12 / 442000

4490G10 / 441800A

pole mounting not included

Mastbefestigung nicht im
Lieferumfang enthalten

4490G11 / 441700A

4490G10 / 441800A

cable entry
Hauseinführung

antenna cable

4490G10 / 441800A

EARTH STRAP (braided):
Erdleitung

10 mm² (0.0155 inch²)
for max. d=10m (32.8 ft)

4 mm² (0.0062 inch²)
for max. d=2.5m (8.2 ft)

changes		drawing number 02247		page 1/1
		Method of Mounting for Outdoor Antennas GPS / DCF77		
		date	20.05.05	System
		name	tvo	
		check		
date	changes	name	size	
			A4	- A02 -

Mounting of Antenna 4490G10 / 441800A

Montage Antennen 4490G10 / 441800A

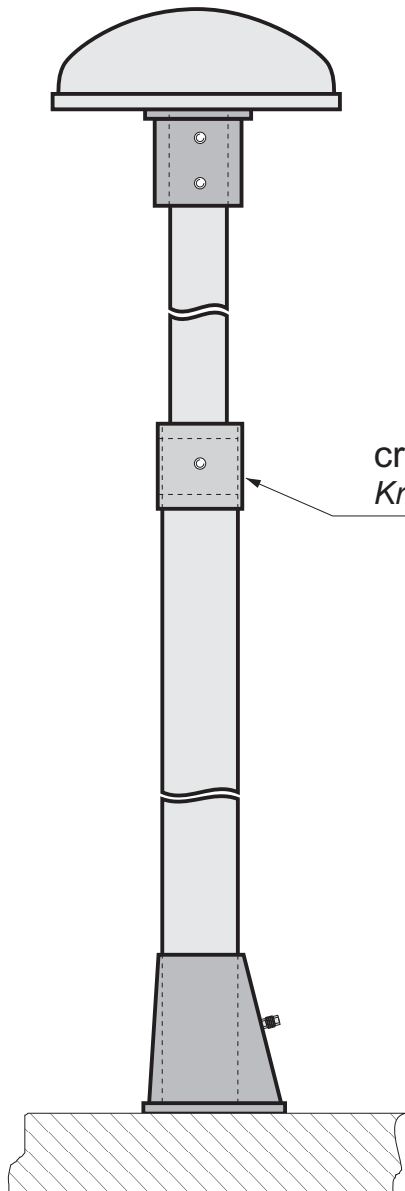

flat roof
Flachdach

cross-head
Kreuzkopf

The tube with the antenna will be supplied unmounted. The cross-head will be plugged according to mounting for wall or flat roof.

Das Rohr mit dem Antennenteller wird unmontiert geliefert. Der Kreuzkopf wird je nach Montagebedarf für Hauswand oder Flachdach gesteckt.

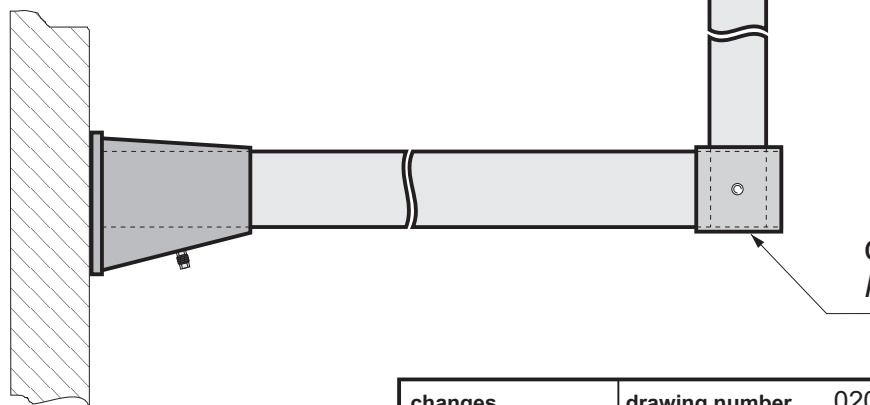

vertical wall
Senkrechte Hauswand

cross-head
Kreuzkopf

changes		drawing number 02036a		page
		Mounting of Antenna 4490G10 / 441800A		
		date	24.09.02	System
		name	tvo	
		check		
20.05.05	Bezeichnung	tvo		
date	changes	name	size	A4
				
				- A03 -

Dimensions of Antenna 4490G10 / 441800A

Abmessungen Antennen 4490G10 / 441800A

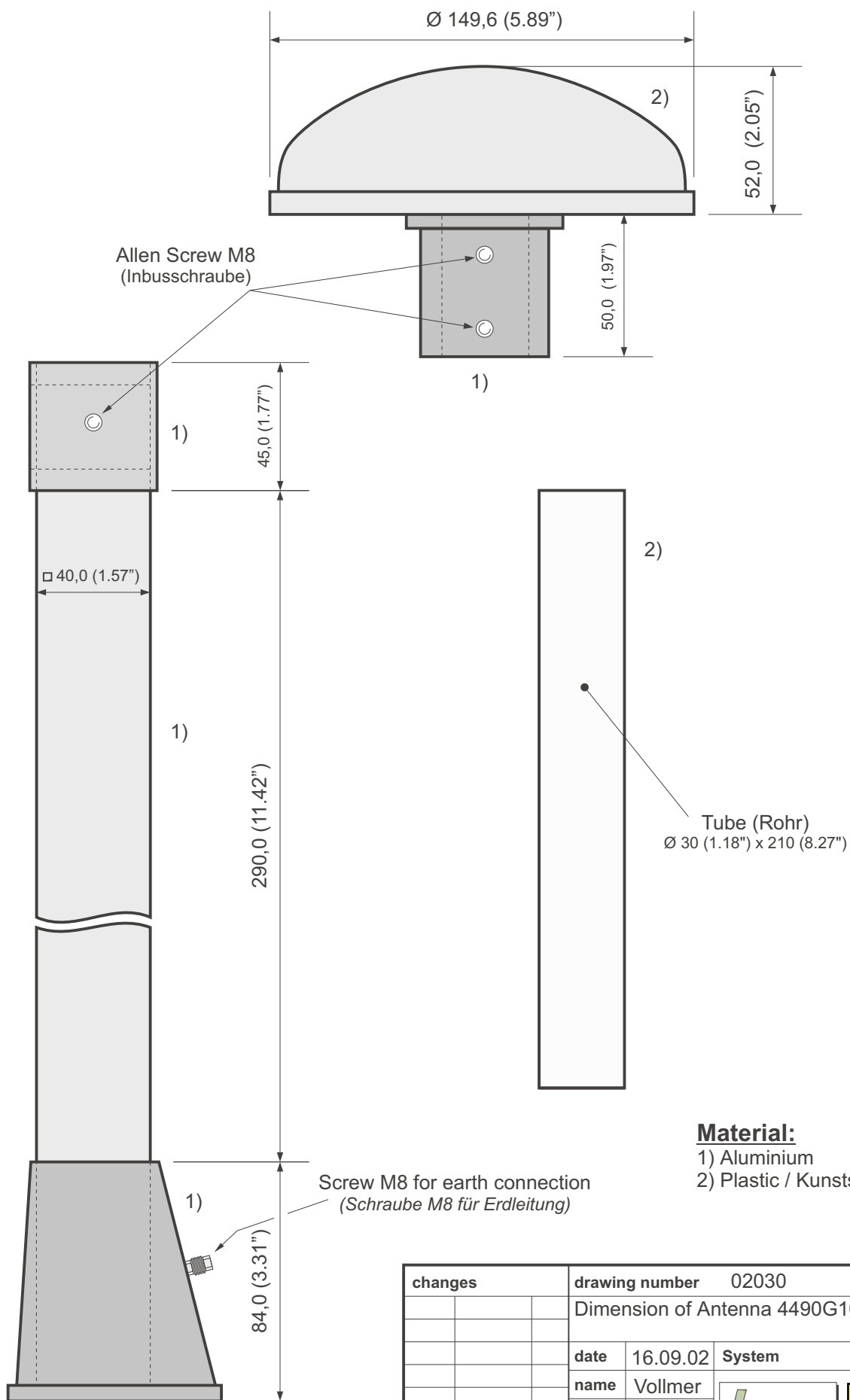

All dimensions in mm (inch)

changes		drawing number 02030		page
		Dimension of Antenna 4490G10 / 441800A		
		date	16.09.02	System
		name	Vollmer	
		check		
date	changes	name	size	A4

hopf
Elektronik GmbH

- A04 -

Dimensions of Antenna 4490G11 / 441700A

Abmessungen Antennen 4490G11 / 441700A

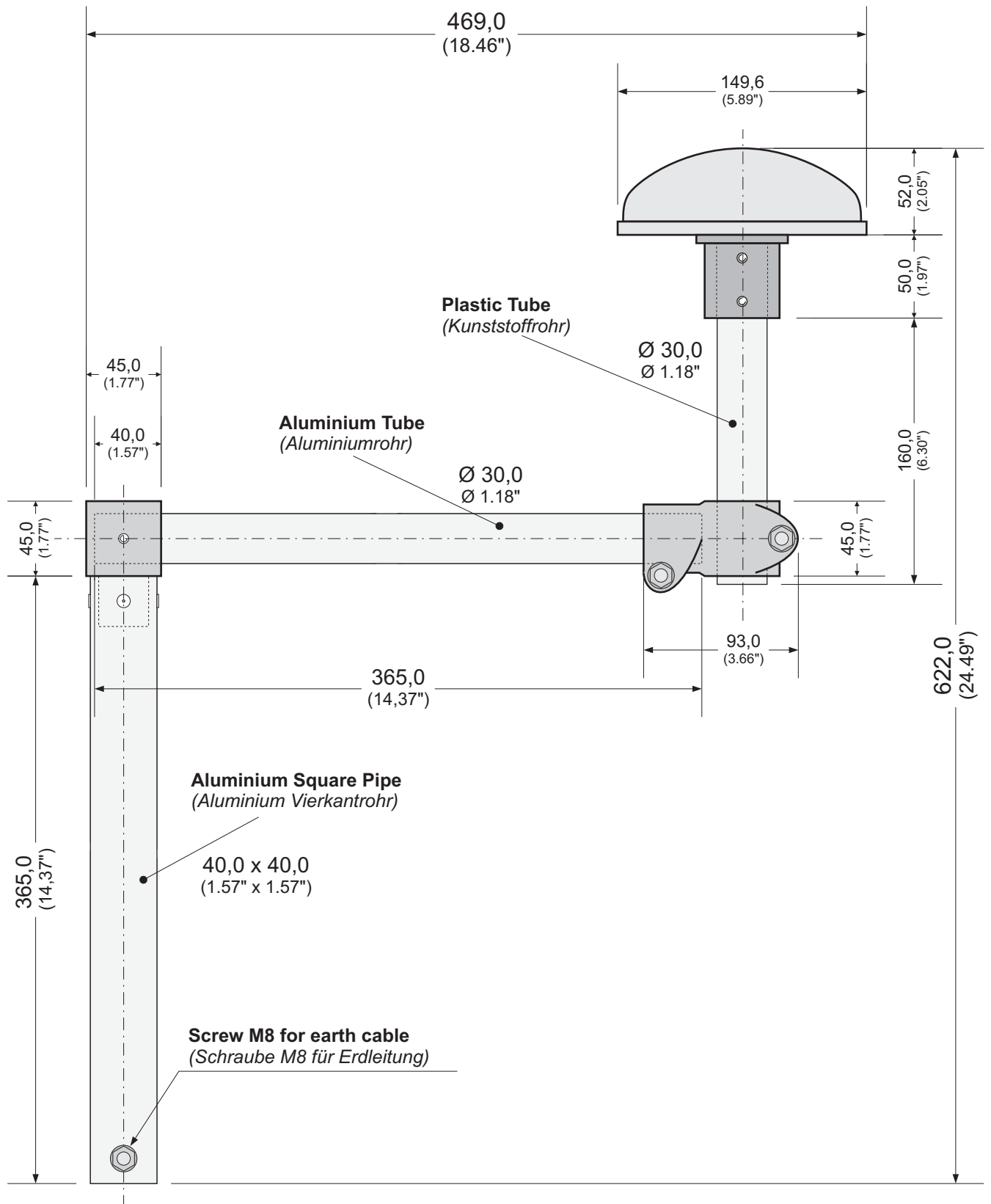

All dimensions in mm (inch)

changes		drawing number 02225		page 1/1
Antenna 4490G11 / 441700A				
date		14.10.04	System	
name		Vollmer		
check				
date	changes	name	size	A4

hopf
Elektronik GmbH

- A04a -

Mounting Bracket for Antenna 4490G10 / 441800A

Montage des Antennensockels für Antennen 4490G10 / 441800A

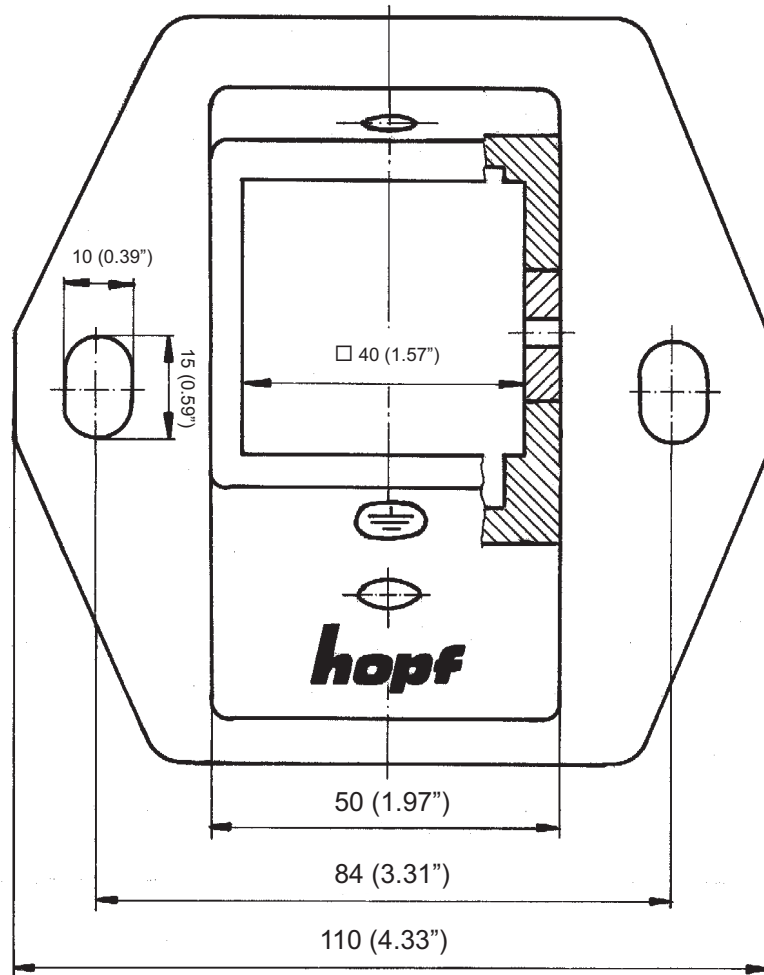

changes		drawing number 02245		page
		Mounting Bracket for Antenna 4490G10 / 441800A		
		date	19.05.05	System
		name	tvo	
		check		
		size	A4	
date	changes	name	- A05 -	

All dimensions in mm (inch)

GPS Reception in 3D and Position Fixed Mode

GPS Empfang im 3D und im "Position Fixed" Modus

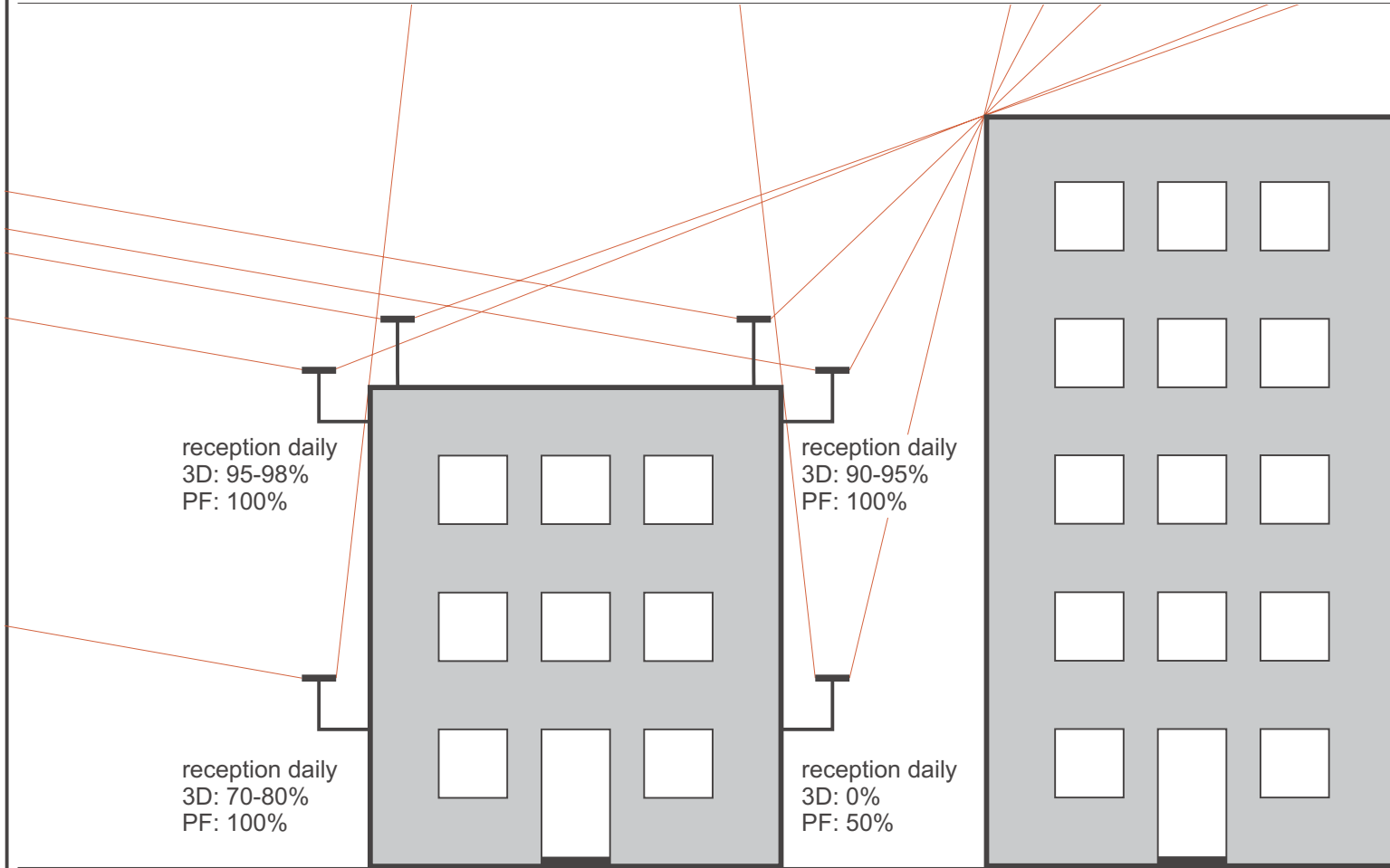

3D: 3D-Reception Mode (Standard)
 Reception of 4 satellites is required
 (position will be calculated)
*Empfang von mindestens 4 Satelliten notwendig
 (Position wird ermittelt)*

PF: Position Fixed Mode
 Reception of only 1 satellite is required
 (position won't be calculated)
*Empfang von nur 1 Satelliten notwendig
 (Position wird nicht ermittelt)*

Detailed Information can be seen in technical description.
Genauere Informationen können der Technischen Beschreibung entnommen werden.

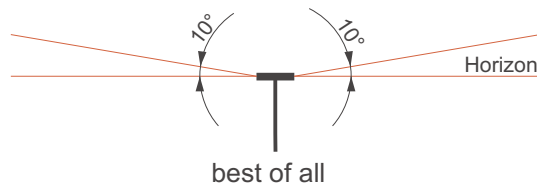

changes		drawing number	ZC01091301	page
		GPS Reception in 3D and Position Fixed Mode		
		date	13.09.01	System
		name	Vollmer	
		check		
		size	A4	
date	changes	name		



post box 1847
 D-58468 Lüdenscheid
 fon: (02351) 938686
 fax: (02351) 459590

GPS antenna cabling for max. 25m (82 ft) cable

with RG59 cable (KA110106)

Cable lengths are also applicable for aerial systems without lightning protection.

ATTENTION!

Danger of destruction of electronics by overvoltage while operation without lightning protection.

Kabellängen auch für Antennenanlagen ohne Blitzschutz gültig

ACHTUNG!

Bei Betrieb ohne Blitzschutz Gefahr der Zerstörung der Elektronik durch Überspannung

GPS clock system

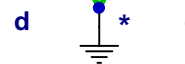
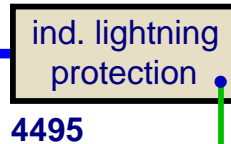
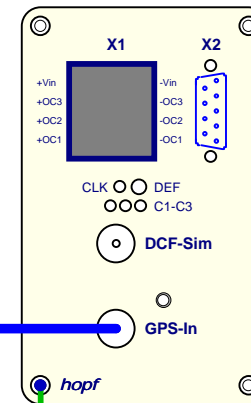

1 2 3 4

D

D

C

C

B

B

A

A

A+B = max. 25m (82.0 ft)
A,B = min. 2m (6.6 ft)

EARTH STRAP (braided):

10 mm² (0.0155 inch²) for max. d=10m (32.8 ft)
4 mm² (0.0062 inch²) for max. d=2.5m (8.2 ft)

* equipotential bonding bar (e.q.b.b.)

changes		drawing number	ZA01091701	sheet
		cable configuration max. 25m		
		date	17.09.01	system
		name	Vollmer	
		check		
		size	A4	
date	changes	name		

Postfach 1847
58468 Lüdenscheid
Tel.: 02351 / 938686
Fax: 02351 / 459590

1 2 3 4

GPS antenna cabling for max. 100m (328 ft) cable

with *hopf* low loss LSZH* cable (KA110109)

* low smoke zero halogen

Cable lengths are also applicable for aerial systems without lightning protection.

ATTENTION!

Danger of destruction of electronics by overvoltage while operation without lightning protection.

Kabellängen auch für Antennenanlagen ohne Blitzschutz gültig

ACHTUNG!

Bei Betrieb ohne Blitzschutz Gefahr der Zerstörung der Elektronik durch Überspannung

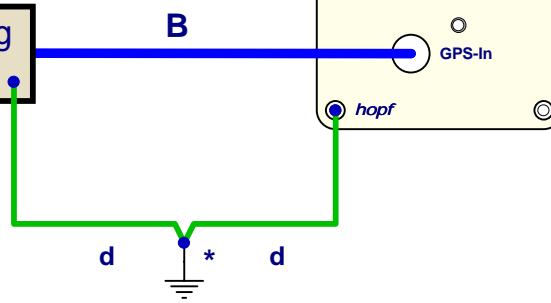
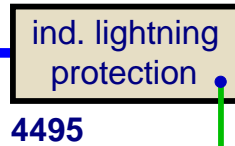
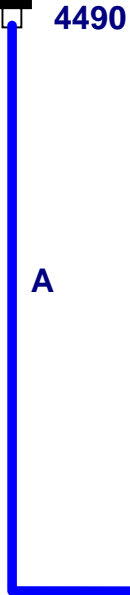
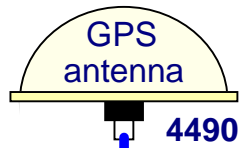

A+B = max. 100m (328.0 ft)
 A,B = min. 5m (16.4 ft)

EARTH STRAP (braided):
 10 mm² (0.0155 inch²) for max. d=10m (32.8 ft)
 4 mm² (0.0062 inch²) for max. d=2.5m (8.2 ft)

* equipotential bonding bar (e.q.b.b.)

GPS clock system

changes		drawing number ZA01052831		sheet
cable configuration max. 100m				
date	28.05.01	system		
15.10.01	text	Vo	name	Grauer
15.08.01	earth strap	Gr	check	
06.07.01	A, B min.	Mai	size	A4
date	changes	name		

Postfach 1847
 58468 Lüdenscheid
 Tel.: 02351 / 938686
 Fax: 02351 / 459590

GPS antenna cabling for max. 200m (656 ft) cable

with *hopf* low loss LSZH* cable (KA110109)

* low smoke zero halogen

Cable lengths are also applicable for aerial systems without lightning protection.

ATTENTION!

Danger of destruction of electronics by overvoltage while operation without lightning protection.

Kabellängen auch für Antennenanlagen ohne Blitzschutz gültig

ACHTUNG!

Bei Betrieb ohne Blitzschutz Gefahr der Zerstörung der Elektronik durch Überspannung

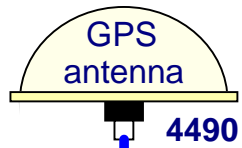

A

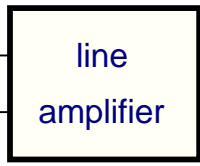

6849

B



4495

C

GPS clock system

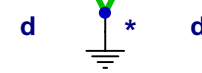
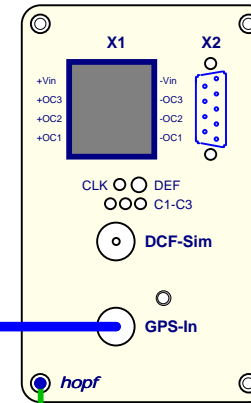

- A = max. 100m (328.0 ft)
- A = min. 50m (164.0 ft)
- B+C = max. 100m (328.0 ft)
- B,C = min. 5m (16.4 ft)

EARTH STRAP (braided):

- 10 mm² (0.0155 inch²) for max. d=10m (32.8 ft)
- 4 mm² (0.0062 inch²) for max. d=2.5m (8.2 ft)

* equipotential bonding bar (e.q.b.b.)

changes			drawing number ZA01052832		sheet
			cable configuration max. 200m		
			date	28.05.01	system
15.10.01	text	Vo	name	Grauer	 Postfach 1847 58468 Lüdenscheid Tel.: 02351 / 938686 Fax: 02351 / 459590
15.08.01	earth strap	Gr	check		
06.07.01	B, C min.	Mai	size	A4	
date	changes	name			

GPS antenna cabling for max. 325m (1066 ft) cable

with *hopf* low loss LSZH* cable (KA110109)

* low smoke zero halogen

Cable lengths are also applicable for aerial systems without lightning protection.

ATTENTION!

Danger of destruction of electronics by overvoltage while operation without lightning protection.

Kabellängen auch für Antennenanlagen ohne Blitzschutz gültig

ACHTUNG!

Bei Betrieb ohne Blitzschutz Gefahr der Zerstörung der Elektronik durch Überspannung

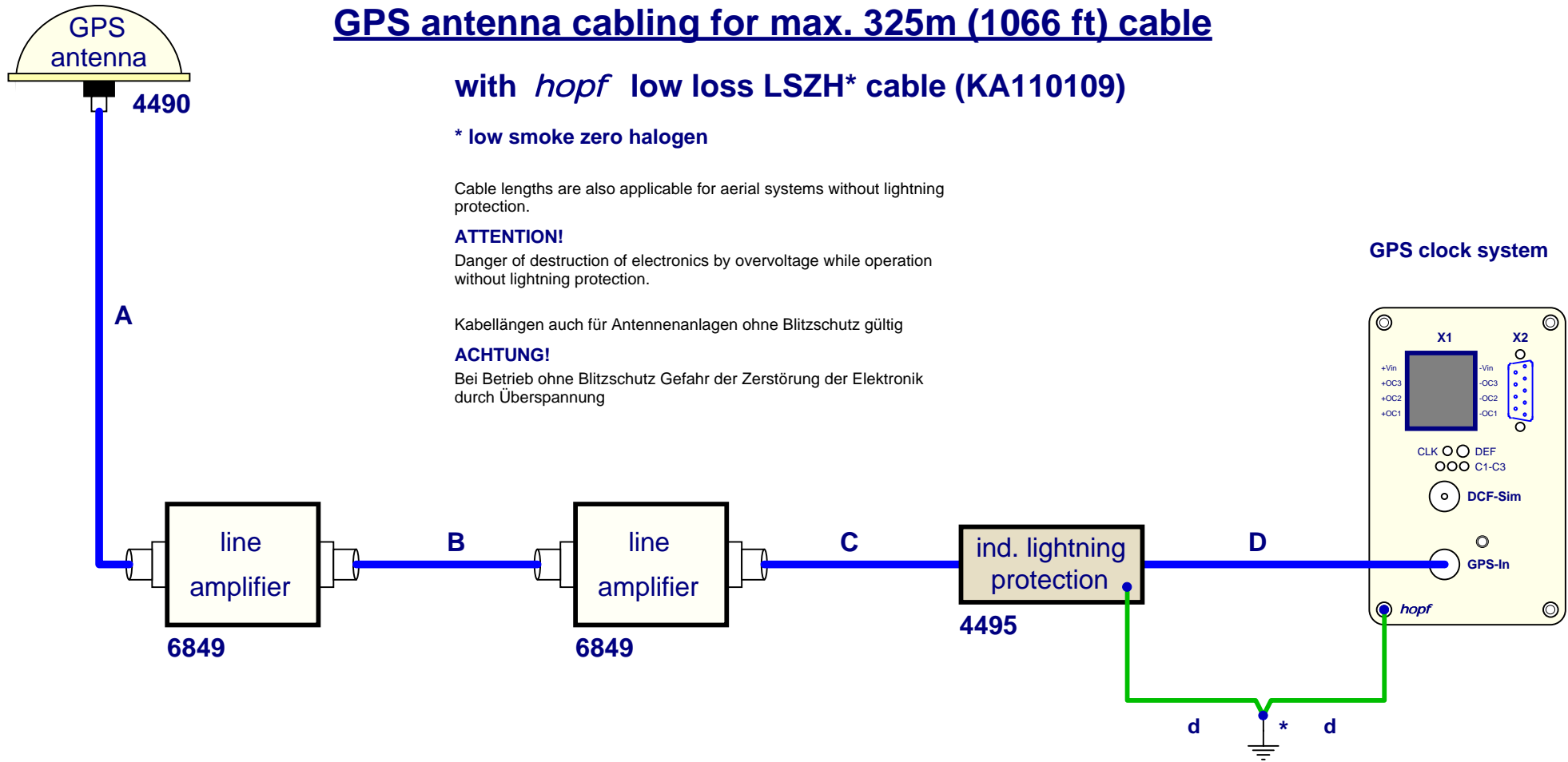

- A = max. 100m (328.0 ft)
- B = max. 125m (410.0 ft)
- A,B = min. 50m (164.0 ft)
- C+D = max. 100m (328.0 ft)
- C,D = min. 5m (16.4 ft)

EARTH STRAP (braided):

- 10 mm² (0.0155 inch²) for max. d=10m (32.8 ft)
- 4 mm² (0.0062 inch²) for max. d=2.5m (8.2 ft)

* equipotential bonding bar (e.q.b.b.)

changes			drawing number ZA01052833		sheet
			cable configuration max. 325m		
			date	28.05.01	system
15.10.01	text	Vo	name	Grauer	 Postfach 1847 58468 Lüdenscheid Tel.: 02351 / 938686 Fax: 02351 / 459590
15.08.01	earth strap	Gr	check		
06.07.01	C, D min.	Mai	size	A4	
date	changes	name			

GPS antenna cabling for Power Splitter 4443 (Configuration 1)

with **hopf** low loss LSZH* cable (KA110109)

* low smoke zero halogen

Cable lengths are also applicable for aerial systems without lightning protection.

ATTENTION!

Danger of destruction of electronics by overvoltage while operation without lightning protection.

Kabellängen auch für Antennenanlagen ohne Blitzschutz gültig

ACHTUNG!

Bei Betrieb ohne Blitzschutz Gefahr der Zerstörung der Elektronik durch Überspannung

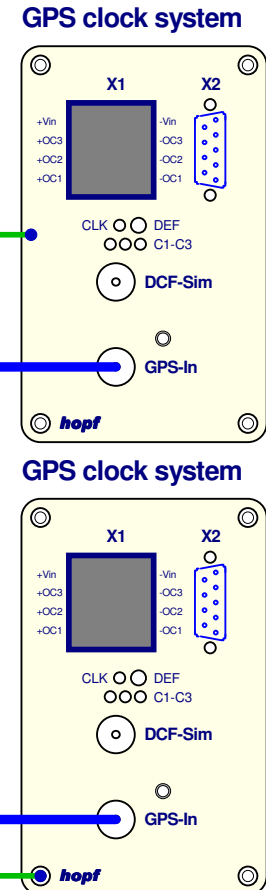
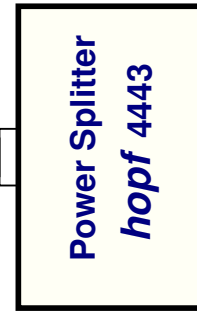
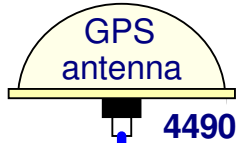

- A = max. 50m (164.0 ft)
- A+B+C = max. 75m (246.0 ft)
- A,B,C = min. 5m (16.4 ft)

EARTH STRAP (braided):
 10 mm² (0.0155 inch²) for max. d=10m (32.8 ft)
 4 mm² (0.0062 inch²) for max. d=2.5m (8.2 ft)

* equipotential bonding bar (e.q.b.b.)

changes		drawing number ZA01062636		sheet
		cable config. (1) for Power Splitter 4443		
		date	26.03.01	system
		name	Grauer	
		check		
		size	A4	
30.01.02	text	Vo		
14.08.01	min.	Gr		
date	changes	name		
			- A11 -	

GPS antenna cabling for Power Splitter 4443 (Configuration 2)

with **hopf** low loss LSZH* cable (KA110109)

* low smoke zero halogen

Cable lengths are also applicable for aerial systems without lightning protection.

ATTENTION!

Danger of destruction of electronics by overvoltage while operation without lightning protection.

Kabellängen auch für Antennenanlagen ohne Blitzschutz gültig

ACHTUNG!

Bei Betrieb ohne Blitzschutz Gefahr der Zerstörung der Elektronik durch Überspannung

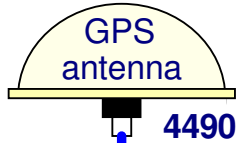

A

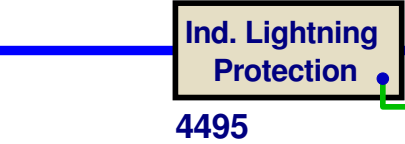
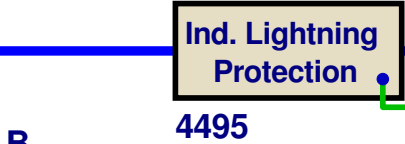
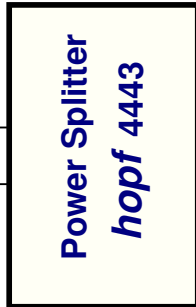

GPS clock system

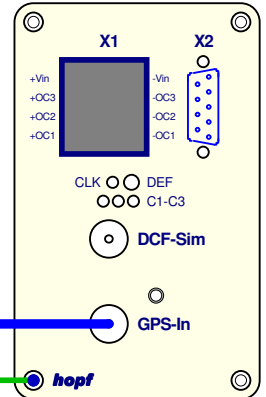

GPS clock system

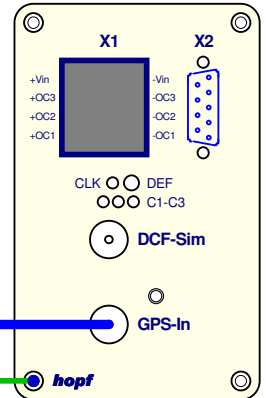

- A = max. 50m (164.0 ft)
- B+C = max. 25m (82.0 ft)
- A+B+C = max. 75m (246.0 ft)
- A,B,C = min. 5m (16.4 ft)

EARTH STRAP (braided):

- 10 mm² (0.0155 inch²) for max. d=10m (32.8 ft)
- 4 mm² (0.0062 inch²) for max. d=2.5m (8.2 ft)

* equipotential bonding bar (e.q.b.b.)

changes		drawing number ZA02013001		sheet
		cable config. (2) for Power Splitter 4443		
date	30.01.02	system		
name	Vollmer			
check				
size	A4			
date	changes	name	size	A4



Assembly of RG59 cable (article no.: KA110106)
 BNC-plug with **crimping technique** (article no.: ST001103)

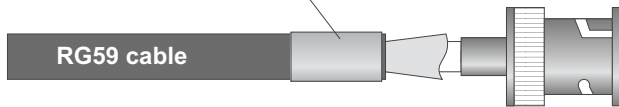
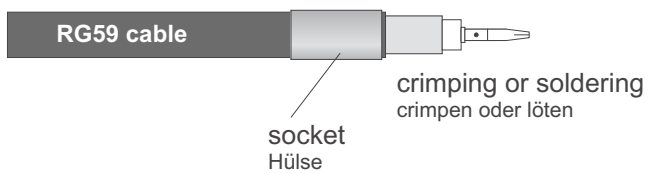
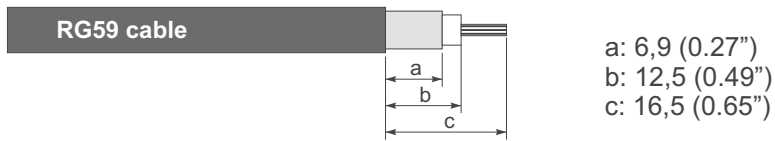

Assembly of RG59 cable (article no.: KA110106)
 BNC-plug with **screw technique** (article no.: ST001115)

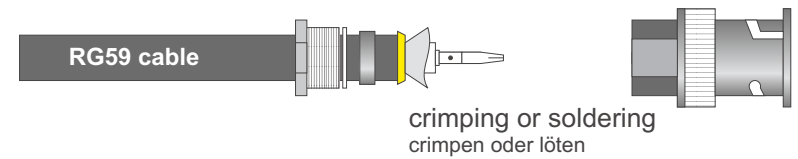
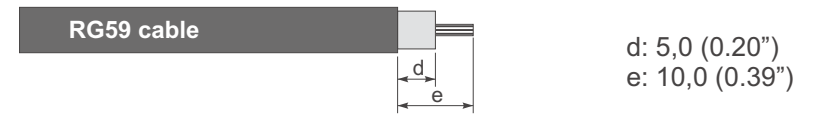

max. Diameter of connector: 15 mm

All dimensions in mm (inch)

changes		drawing number ZC01083105		page
		Assembly of RG59 cable		
		date	31.08.01	System
		name	Vollmer	
		check		
		size	A4	
date	changes	name		



post box 1847
 D-58468 Lüdenscheid
 fon: (02351) 938686
 fax: (02351) 459590

Assembly of **hopf** low loss LSZH* cable (article no.: KA110109) BNC-plug with **screw technique** (article no.: ST001106)

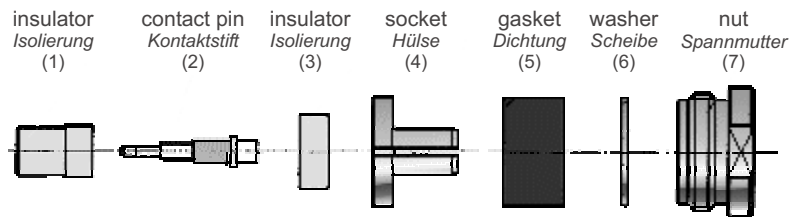

Before mounting, push gasket (5), washer (6) and nut (7) onto the end of the cable.
Dichtung (5), Scheibe (6) und Spannmutter (7) vor der Montage auf das Leitungsende schieben.

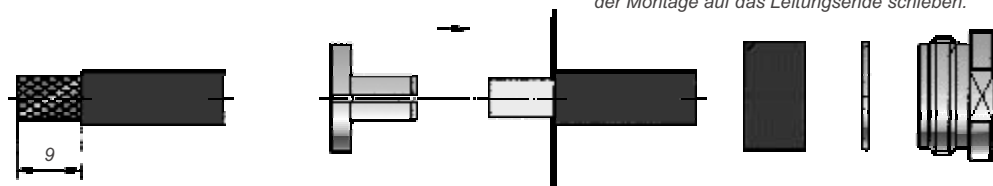

Insulation unit for BNC plug
Abisoliermaß für BNC-Stecker

Turn back netting 90°. Insert the socket between foil and netting up to the attempt. Use knife to carefully slit and remove excess foil.
Geflecht um 90° abwinkeln. Hülse zwischen Folie und Geflecht bis zum Anschlag einschieben. Überstehende Folie mit Messer anritzen und entfernen.

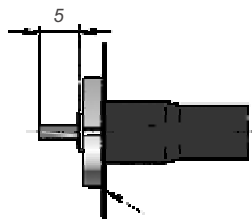

Cut of excess netting. Insulate the internal conductor. Mounting insulator (3) and solder on contact pin (2).
Überstehendes Geflecht abschneiden. Innenleiter abisolieren. Isolierung (3) aufstecken und Kontaktstift (2) anlöten.

max. Diameter of connector: 18 mm

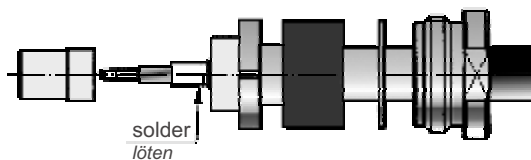
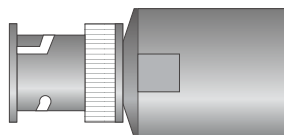

Before mounting the housing, the gasket (5) must be pushed up to the socket (4).
Vor dem Aufstecken des Gehäuses, Dichtung (5) bis an die Hülse (4) schieben.

* low smoke zero halogen

changes		drawing number		ZC01090403	page
		Assembly of hopf low loss LSZH cable			
		date	04.09.01	System	
		name		Vollmer	
		check			
date	changes	name	size	A4	
					
				post box 1847 D-58468 Lüdenscheid fon: (02351) 938686 fax: (02351) 459590	

Dimensions of Indirect Lightning Protector (article no. for GPS: FG4495G0 / for DCF77: FG444100)

Abmessungen indirekter Blitzschutz

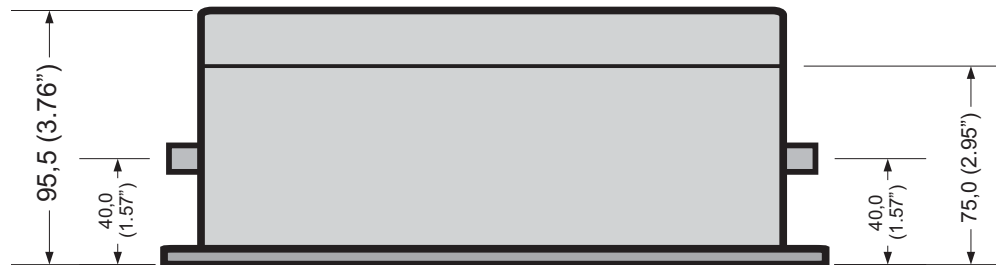
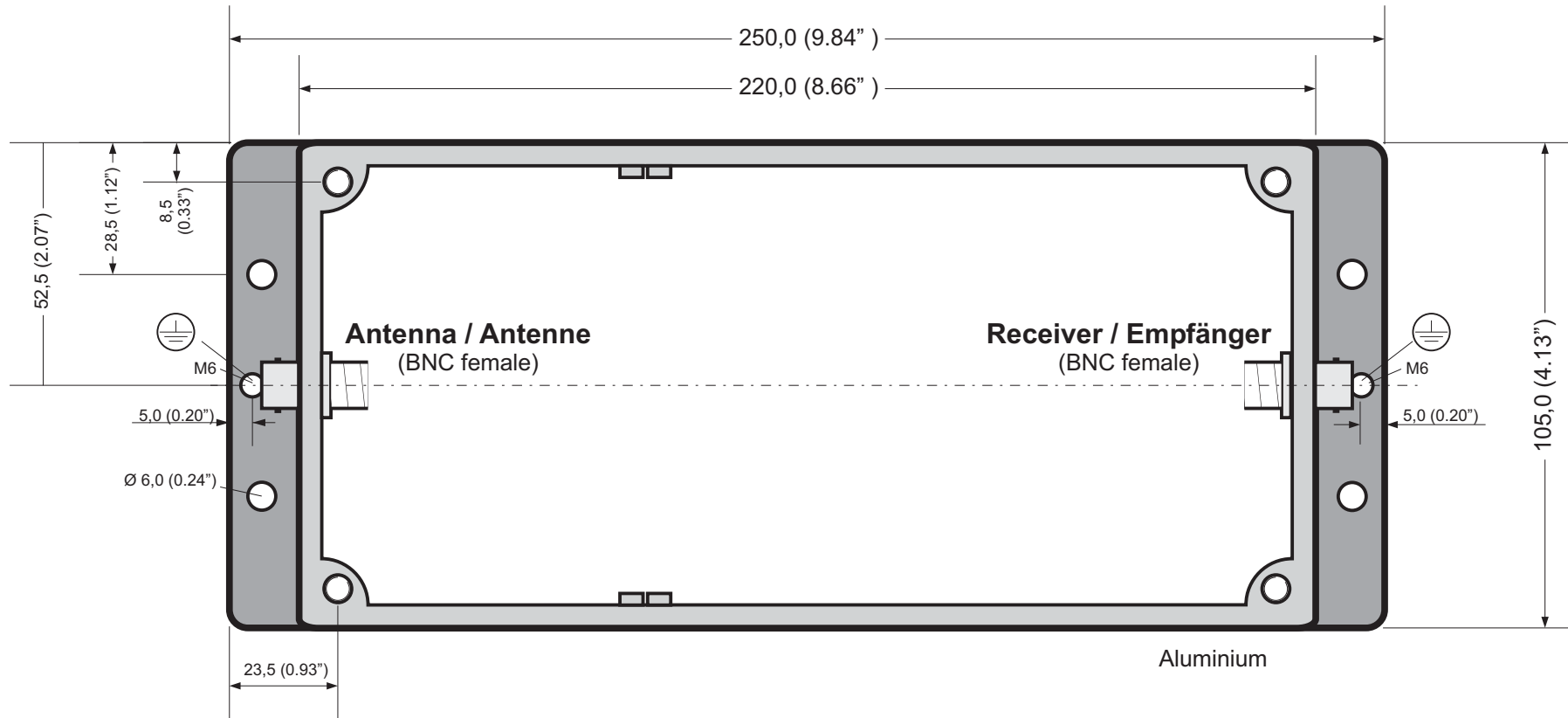

All dimensions in mm (inch)

changes		drawing number 02208a		page 1/1
Dimensions of Indirect Lightning Protector				
date		10.08.04	System	
name		tvo		
check				
19.05.05	M6, BNC	tvo		
date	changes	name	size	A4

- A15 -

Dimensions of Line Amplifier (article no.: FG6849G0)

Abmessungen Leitungsverstärker

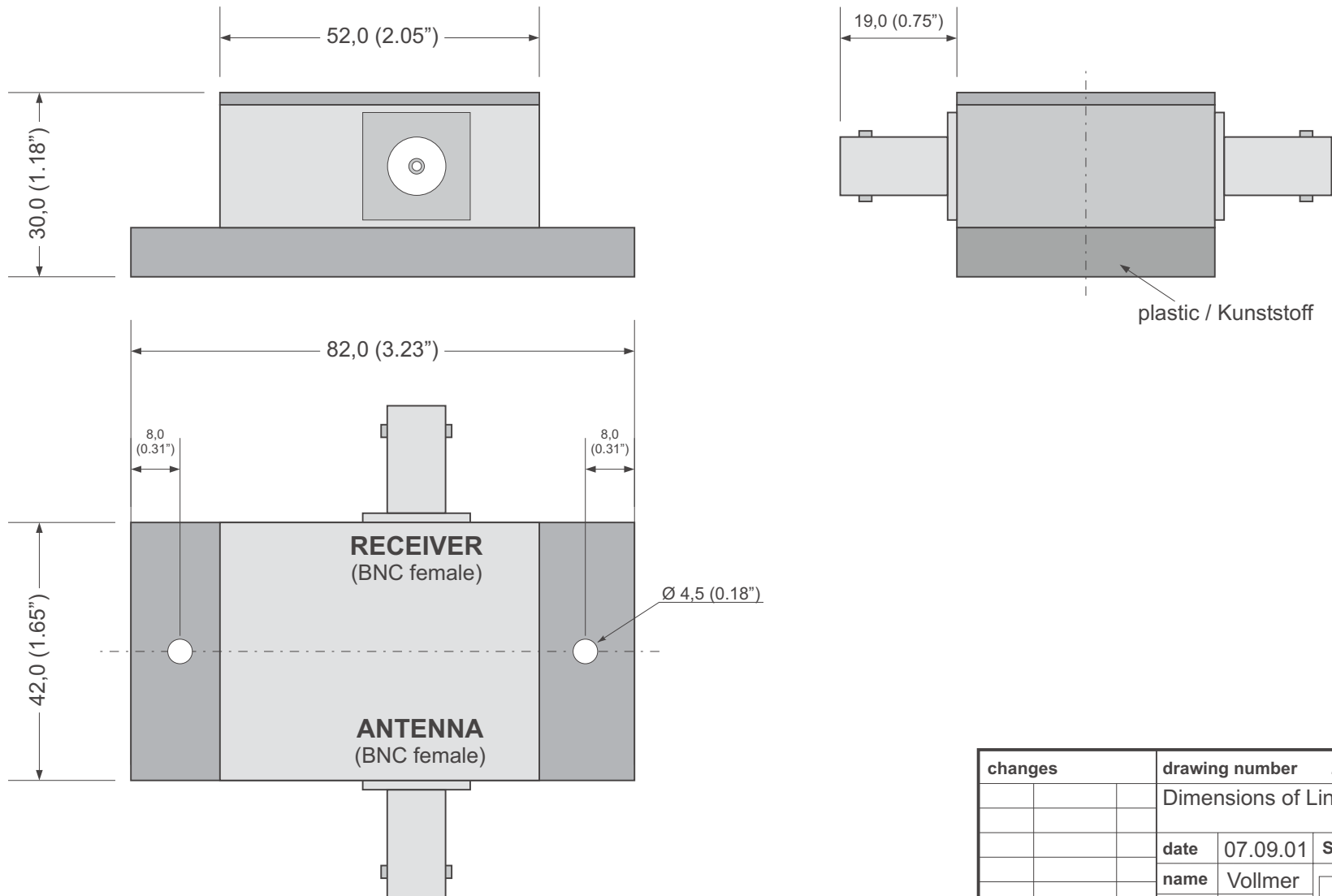

All dimensions in mm (inch)

changes		drawing number ZC01090702		page
		Dimensions of Line Amplifier		
		date	07.09.01	System
		name	Vollmer	
		check		
		size	A4	
date	changes	name		
			post box 1847 D-58468 Lüdenscheid fon: (02351) 938686 fax: (02351) 459590	

Dimensions of GPS Power Splitter (article no.: FG4443G00)

Abmessungen GPS Power Splitter

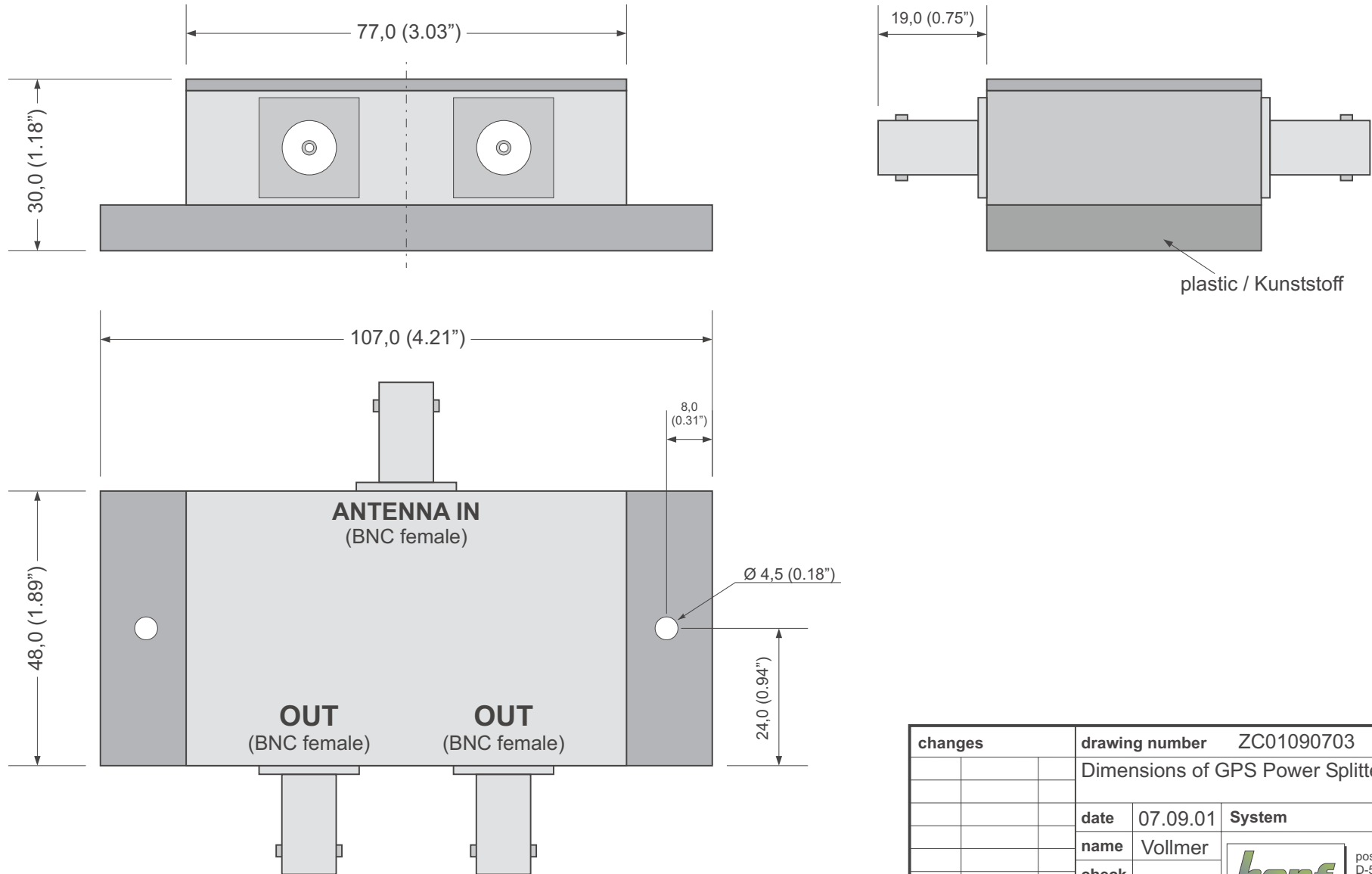

All dimensions in mm (inch)

changes		drawing number ZC01090703		page
		Dimensions of GPS Power Splitter		
		date	07.09.01	System
		name	Vollmer	
		check		
		size	A4	
date	changes	name	 post box 1847 D-58468 Lüdenscheid fon: (02351) 938686 fax: (02351) 459590	