

TB

Exhaust fans, top mounting Torrino di estrazione, da tetto Dachventilator, Installation an der Oberseite Extractores de techo

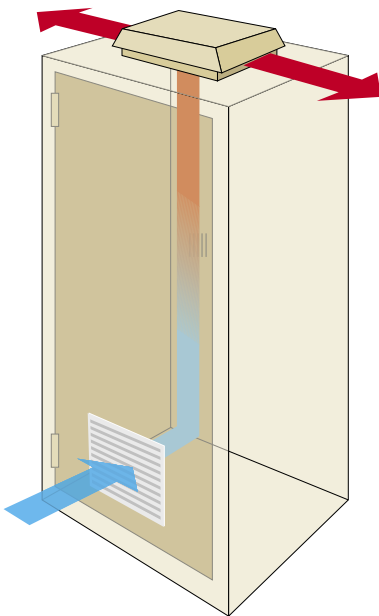

| Air volume Portata aria Luftmenge des Gritters Caudal de aire | Power Supply Alimentazione Stromversorgung Tensión de alimen | Dimensions Dimensioni Abmessungen Dimensiones | | | Article Articolo Artikel Artículo | PAGE PAG SEITE PAG |
|--|---|--|-----|-----|--|-----------------------------|
| | V - ph - Hz | H/A | W/L | D/P | | |
| 575m ³ /h | 230-1-50/60 | 105 | 460 | 380 | TB19000220 | 67 |
| 575m ³ /h | 115-1-50/60 | 105 | 460 | 380 | TB19000222 | 67 |
| 860m ³ /h | 230-1-50/60 | 105 | 460 | 380 | TB22000220 | 68 |
| 860m ³ /h | 115-1-50/60 | 105 | 460 | 380 | TB22000222 | 68 |
| 1450m ³ /h | 230-1-50/60 | 160 | 520 | 400 | TB25000220 | 69 |
| 2365m ³ /h | 230-1-50/60 | 300 | 600 | 550 | TB35000220 | 70 |

GENERAL FEATURES

- Color RAL 7032 gray
- Ball bearing radial fans, with internal amperometric protection
- High dynamic pressure
- Operating temperature range -20/+55°C
- Power supply chord 3m long according to applicable CE regulation

CARATTERISTICHE GENERALI

- Colore grigio RAL 7032
- Ventilatori radiali su cuscinetti con protezione amperometrica interna
- Alta prevalenza
- Campo di temperatura operativo -20/+55°C
- Cavo di alimentazione lungo 3m conforme alle normative CE vigenti

ALLGEMEINE MERKMALE

- RAL-Farbe: grau 7032
- Radiallüfter auf Lagern mit internem, amperometrischem Schutz
- Hohe Förderhöhe
- Betriebstemperaturbereich -20/+55°C
- Netzkabel, 3 m lang, laut geltender CE-Norm

CARACTERÍSTICAS COMUNES

- Color gris RAL 7032
- Ventiladores radiales sobre cojinetes con protección amperométrica interna
- Considerable altura de elevación
- Escala de temperaturas de funcionamiento -20/+55°C
- Cable de alimentación de 3 m de longitud conforme con las normativas CE vigentes

TB



Ball bearings:
Ball bearing fans.

Ball bearings:
Ventilatori su cuscinetti a sfera

Ball bearings:
Luefter auf Lagern

Ball bearings:
Ventiladores sobre cojinetes

OPTIONAL



IP54
The units can be delivered with IP54 protection degree.

IP54
I prodotti possono essere richiesti con IP54.

IP54
Die Artikel sind mit IP54 erhältlich.

IP54
Los artículos pueden solicitarse con IP54.



INOX
The units can be delivered with casing in AISI 304 stainless steel.

INOX
I prodotti possono essere richiesti con carpenteria in acciaio AISI 304.

INOX
Die Artikel sind mit Außengehäuse aus Edelstahl AISI 304 erhältlich.

INOX
Los artículos pueden solicitarse con carpintería exterior de acero AISI 304.



COLOR
The units can be delivered with other RAL colours.

COLOR
I prodotti possono essere richiesti con altri colori RAL.

COLOR
Die Artikel sind mit anderer Farben erhältlich.

COLOR
Los artículos pueden solicitarse con diversos RAL pintura.

ACCESSORIES - ACCESSORI - ZUBEHÖR - ACCESORIOS



TMF
Mechanical thermostat 0-60°C

TMF
Termostato meccanico 0-60°C

TMF
Mechanischer Thermostat 0-60°C

TMF
Termostato mecanico 0-60°C

Tb Tb190

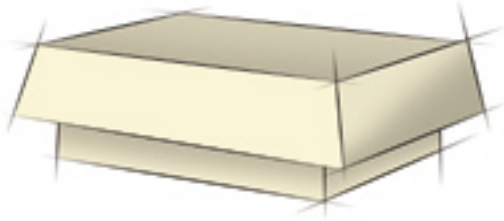

Performance - Resa - Leistung - Rendimiento



Air flow rate - Portata aria [m³/h]
Luftmenge - Caudal de aire [m³/h]

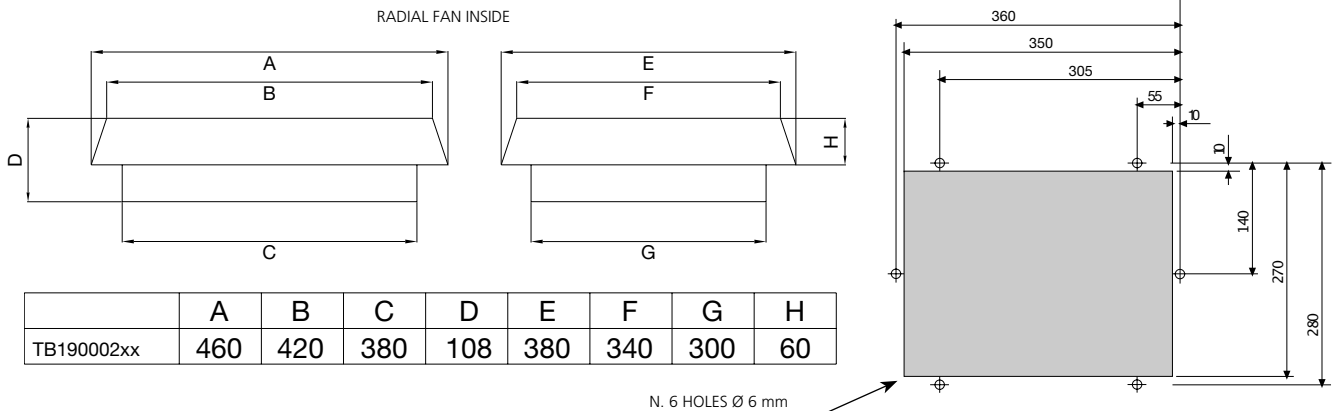

| CODE - CODICE - CODE - CÓDIGO | TB19000220 | TB19000222 | TB190 |
|--|------------|-------------|-------------|
| Approvals file number - Protocollo certificazioni Bescheinigungen - Protocolo certificaciones | - | - | - |
| Voltage / Phase / Frequency - Tensione / Fase / Frequenza Spannung / Phase / Freqenz - Voltaje / Fase / Frecuencia | V-ph-Hz | 230-1-50/60 | 115-1-50/60 |
| Height / Width / Depth - Altezza / Larghezza / Profondità Höhe / Breite / Tiefe - Altura / Ancho / Profundidad | mm | 105x460x380 | 105x460x380 |
| Protection fuses - Fusibili di protezione Schmelzsicherungen - Fusibles de protección | A | 4 | 10 |
| Power absorbed - Potenza assorbita Leistungsaufnahme - Potencia absorbida | W | 80 | 80 |
| Fan capacitor - Condensatore ventilatore Lüfterkondensatoren - Condensador ventilador | µf | 2 | 6 |
| Fan flow, free air - Portata aria ventil., bocca libera Luftmenge, freie Öffnung - Caudal de aire ventil., bocca libera | m³/h | 575** | 575** |
| Temperature limits - Limiti temperatura Temperaturbereich - Límites temperatura | °C | -20/+55 | -20/+55 |
| Side cabinet protection degree - Protezione lato armadio Schutzgrad Schrankseite - Protección lado armario | IP | 44* | 44* |
| Noise level - Rumorosità Geräuschpegel - Nivel de ruido | dB(A) | 62 | 62 |
| Weight - Peso Gewicht - Peso | kg | 5,8 | 5,8 |
| Shipment weight / Shipment volume - Peso / Volume spedizione Frachtgewicht / -volumen - Peso / Volumen expedición | kg/m³ | 7/0,03 | 7/0,03 |
| Filter fans quantity - Quantità griglie Lüftungsgittermenge - Cantidades rejillas | | 1xGNF25 | 1xGNF25 |
| *optional: IP54 - a richiesta: IP54 **350 m³/h for IP54 - 350 m³/h per IP54 *zur Anfrage: IP54 - a demanda: IP54 **350 m³/h für IP54 - 350 m³/h para IP54 | | | |

Tb Tb220

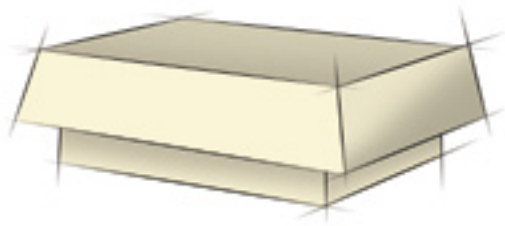

Performance - Resa - Leistung - Rendimiento

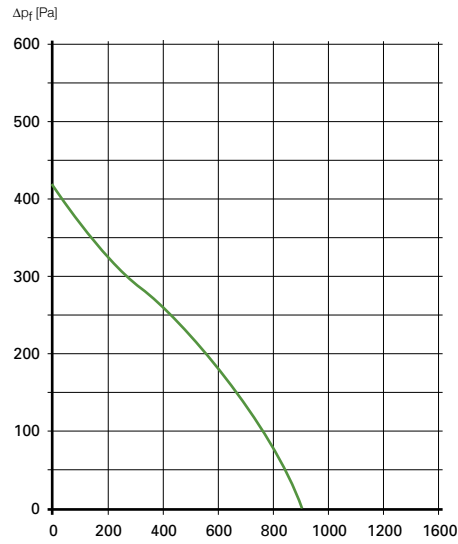

Air flow rate - Portata aria [m³/h]
Luftmenge - Caudal de aire [m³/h]

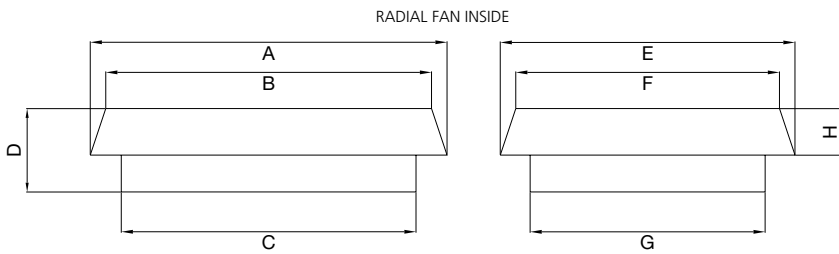

| | A | B | C | D | E | F | G | H |
|------------|-----|-----|-----|-----|-----|-----|-----|----|
| TB220002xx | 460 | 420 | 380 | 108 | 380 | 340 | 300 | 60 |

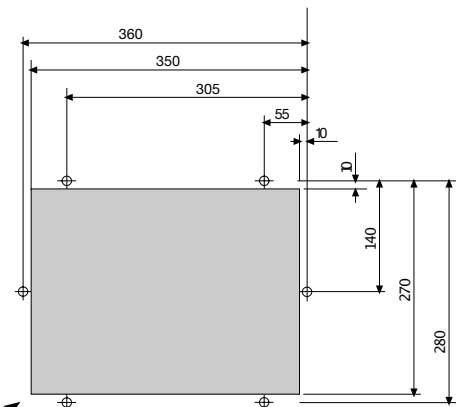

N. 6 HOLES Ø 6 mm

| CODE - CODICE - CODE - CÓDIGO | | TB22000220 | TB22000222 |
|--|---------|-------------|-------------|
| Approvals file number - Protocollo certificazioni Bescheinigungen - Protocolo certificaciones | | - | - |
| Voltage / Phase / Frequency - Tensione / Fase / Frequenza Spannung / Phase / Frequenz - Voltaje / Fase / Frecuencia | V-ph-Hz | 230-1-50/60 | 115-1-50/60 |
| Height / Width / Depth - Altezza / Larghezza / Profondità Höhe / Breite / Tiefe - Altura / Ancho / Profundidad | mm | 105x460x380 | 105x460x380 |
| Protection fuses - Fusibili di protezione Schmelzsicherungen - Fusibles de protección | A | 1 | 2 |
| Power absorbed - Potenza assorbita Leistungsaufnahme - Potencia absorbida | W | 85 | 85 |
| Fan capacitor - Condensatore ventilatore Lüfterkondensatoren - Condensador ventilador | µf | 3 | 10 |
| Fan flow, free air - Portata aria ventil., bocca libera Luftmenge, freie Öffnung - Caudal de aire ventil., boca libera | m³/h | 860** | 860** |
| Temperature limits - Limiti temperatura Temperaturbereich - Límites temperatura | °C | -20/+55 | -20/+55 |
| Side cabinet protection degree - Protezione lato armadio Schutzgrad Schrankseite - Protección lado armario | IP | 44* | 44* |
| Noise level - Rumorosità Geräuschpegel - Nivel de ruido | dB(A) | 70 | 70 |
| Weight - Peso Gewicht - Peso | kg | 8 | 8 |
| Shipment weight / Shipment volume - Peso / Volume spedizione Frachtgewicht / -volumen - Peso / Volumen expedición | kg/m³ | 9/0,03 | 9/0,03 |
| Filter fans quantity - Quantità griglie Lüftungsgittermenge - Cantidades rejillas | | 1xGNF30 | 1xGNF30 |
| *optional: IP54 - a richiesta: IP54 **610 m³/h for IP54 - 610 m³/h per IP54 *zur Anfrage: IP54 - a demanda: IP54 **610 m³/h für IP54 - 610 m³/h para IP54 | | | |

Tb Tb250

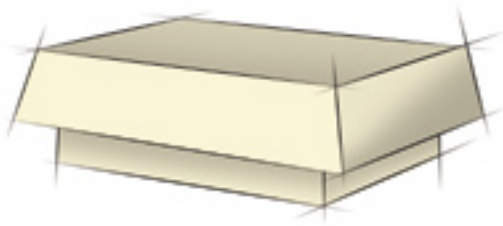

Performance - Resa - Leistung - Rendimiento

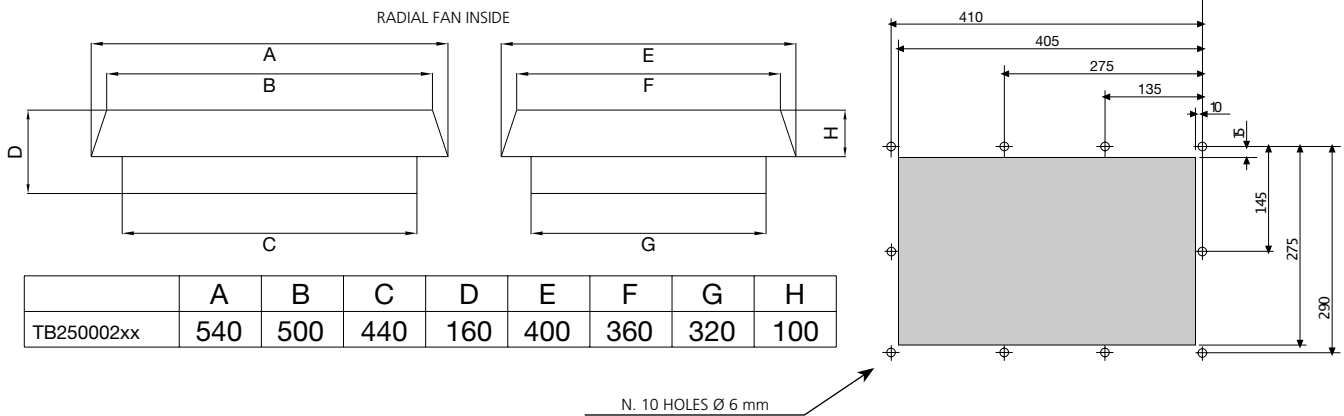
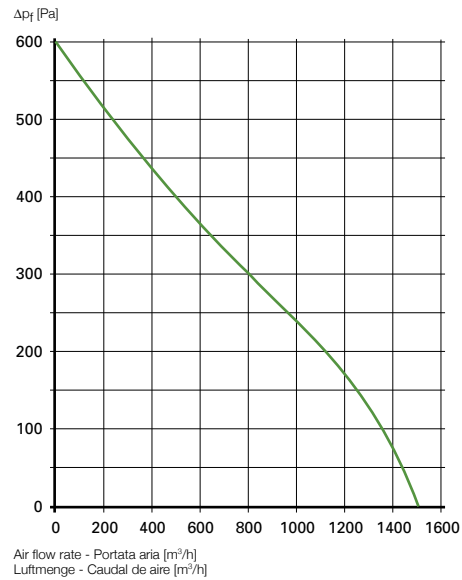

| CODE - CODICE - CODE - CÓDIGO | | TB25000220 | TB250 |
|--|---------|-------------|-------------|
| Approvals file number - Protocollo certificazioni Bescheinigungen - Protocolo certificaciones | | - | - |
| Voltage / Phase / Frequency - Tensione / Fase / Frequenza Spannung / Phase / Frequenz - Voltaje / Fase / Frecuencia | V-ph-Hz | 230-1-50/60 | - |
| Height / Width / Depth - Altezza / Larghezza / Profondità Höhe / Breite / Tiefe - Altura / Ancho / Profundidad | mm | 160x560x400 | 160x560x400 |
| Protection fuses - Fusibili di protezione Schmelzsicherungen - Fusibles de protección | A | 2 | - |
| Power absorbed - Potenza assorbita Leistungsaufnahme - Potencia absorbida | W | 155 | - |
| Fan capacitor - Condensatore ventilatore Lüfterkondensatoren - Condensador ventilador | µf | 5 | - |
| Fan flow, free air - Portata aria ventil., bocca libera Luftmenge, freie Öffnung - Caudal de aire ventil., boca libera | m³/h | 1450** | - |
| Temperature limits - Limiti temperatura Temperaturbereich - Límites temperatura | °C | -20/+55 | - |
| Side cabinet protection degree - Protezione lato armadio Schutzgrad Schrankseite - Protección lado armario | IP | 44* | 44* |
| Noise level - Rumorosità Geräuschpegel - Nivel de ruido | dB(A) | 76 | - |
| Weight - Peso Gewicht - Peso | kg | 12 | 8 |
| Shipment weight / Shipment volume - Peso / Volume spedizione Frachtgewicht / -volumen - Peso / Volumen expedición | kg/m³ | 13/0,047 | 9/0,047 |
| Filter fans quantity - Quantità griglie Lüftungsgittermenge - Cantidades rejillas | | 2xGNF30 | 2xGNF30 |
| *optional: IP54 - a richiesta: IP54 **1100 m3/h for IP54 - 1100 m3/h per IP54 *zur Anfrage: IP54 - a demanda: IP54 **1100 m3/h für IP54 - 1100 m3/h para IP54 | | | |

Tb Tb350

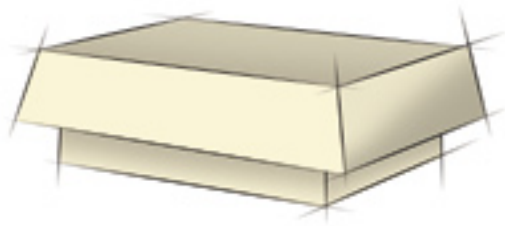

Performance - Resa - Leistung - Rendimiento

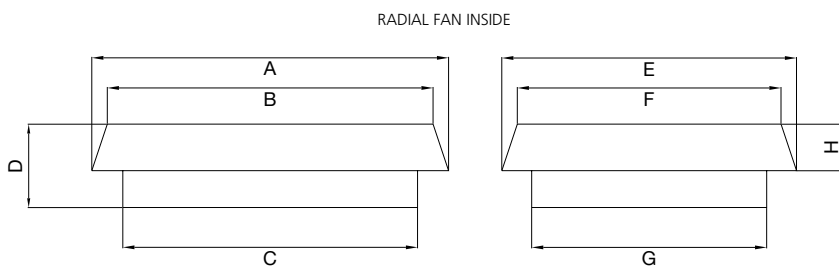
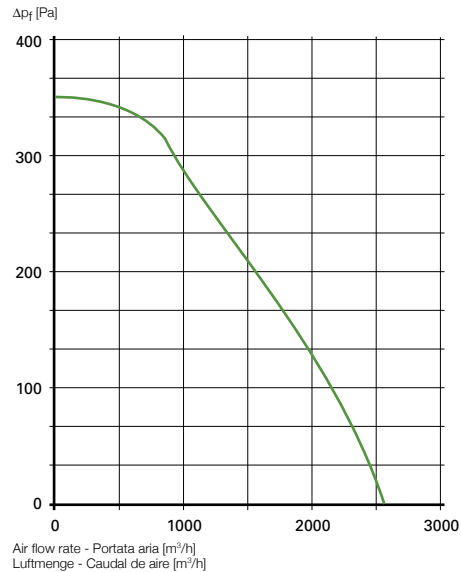

| | A | B | C | D | E | F | G | H |
|------------|-----|-----|-----|-----|-----|-----|-----|-----|
| TB350002xx | 600 | 540 | 480 | 265 | 550 | 490 | 470 | 190 |

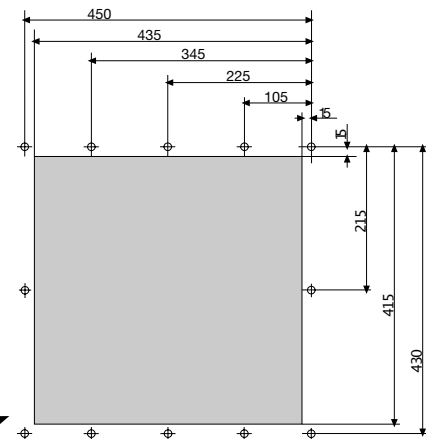

| CODE - CODICE - CODE - CÓDIGO | | TB35000220 | TB350 |
|--|-------------------|-------------|-------------|
| Approvals file number - Protocollo certificazioni Bescheinigungen - Protocolo certificaciones | | - | - |
| Voltage / Phase / Frequency - Tensione / Fase / Frequenza Spannung / Phase / Frequenz - Voltaje / Fase / Frecuencia | V-ph-Hz | 230-1-50/60 | - |
| Height / Width / Depth - Altezza / Larghezza / Profondità Höhe / Breite / Tiefe - Altura / Ancho / Profundidad | mm | 300x600x550 | 300x600x550 |
| Protection fuses - Fusibili di protezione Schmelzsicherungen - Fusibles de protección | A | 2 | - |
| Power absorbed - Potenza assorbita Leistungsaufnahme - Potencia absorbida | W | 170 | - |
| Fan capacitor - Condensatore ventilatore Lüfterkondensatoren - Condensador ventilador | µf | 6 | - |
| Fan flow, free air - Portata aria ventil., bocca libera Luftmenge, freie Öffnung - Caudal de aire ventil., bocca libera | m ³ /h | 2365** | - |
| Temperature limits - Limiti temperatura Temperaturbereich - Límites temperatura | °C | -20/+55 | - |
| Side cabinet protection degree - Protezione lato armadio Schutzgrad Schrankseite - Protección lado armario | IP | 44* | 44* |
| Noise level - Rumorosità Geräuschpegel - Nivel de ruido | dB(A) | 77 | - |
| Weight - Peso Gewicht - Peso | kg | 20 | 15 |
| Shipment weight / Shipment volume - Peso / Volume spedizione Frachtgewicht / -volumen - Peso / Volumen expedición | kg/m ³ | 21/0,25 | 16/0,25 |
| Filter fans quantity - Quantità griglie Lüftungsgittermenge - Cantidades rejillas | | 6xGNF30 | 6xGNF30 |
| *optional: IP54 - a richiesta: IP54 **1865 m ³ /h for IP54 - 1865 m ³ /h per IP54 *zur Anfrage: IP54 - a demanda: IP54 **1865 m ³ /h für IP54 - 1865 m ³ /h para IP54 | | | |